



## Montgomery College Germantown Campus Utility Master Plan

Final Report

June 2022

BKM No. 19021.01

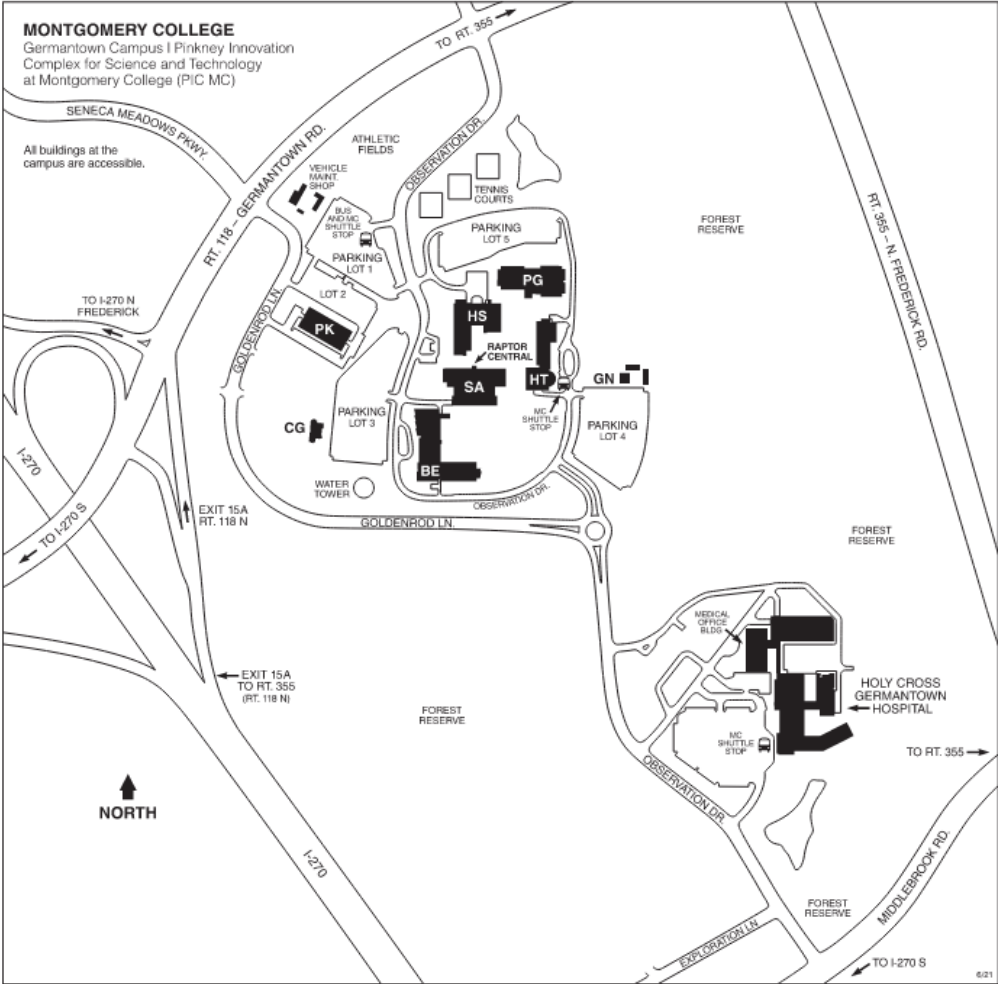

## FORWARD

This and earlier Utilities Master Plans have been prepared to support their respective Facilities Master Plans and to provide utility details useful to planners, designers, and operations staff. The recommendations in these plans have been based upon knowledge of existing technology and practices. Climate change and resulting impacts are influencing master planning efforts, some of which are being addressed in this current plan.

## MONTGOMERY COLLEGE SUSTAINABILITY STATEMENT

In December 2017, Montgomery County Council declared a climate emergency. In response, the Montgomery County Executive published a Climate Action Plan (CAP), June 2021, with the goal of reducing Greenhouse Gas (GHG) by 80% by 2027 and 100% by 2035. The Executive also published Building Energy Performance standards (BEPS), which was introduced to the County Council as Bill 16-21, on May 4, 2021. BEPS requires all buildings, 25,000 Gross Square Foot (GSF) and larger, to benchmark and establish a plan to reduce GHG by the proposed CAP dates.

Future Facilities Master Plans and Utilities Master Plans should address both the CAP and BEPS, specifically in the following area:

- **Buildings:** Increase energy conservation and efficiency, decrease fossil fuel use in buildings, and support carbon neutral building design.
- **Carbon Sequestration:** Retain, increase, and restore terrestrial ecosystems, including forest, meadows, wetlands, green spaces, and urban trees.
- **Climate Adaptation Actions:** Provide suitable infrastructure and tools to reduce the risks and impacts of more extreme climate hazards, i.e., resilience, enhanced storm water management, and green infrastructure.
- **Climate Governance Actions:** Align and orient staffing, technical capacity, process, and decision-making to address climate change.
- **Clean Energy Actions:** Ensure carbon-free electricity, expand renewable electricity generation and use of distributed energy resources.
- **How Can I act on Climate Change:** Public awareness for transportation, home energy, business, consumption, and resilience.
- **Public Engagement, Partnerships, and Education Actions:** Facilitate inclusive, community-driven leadership, build strategic partnerships, empower youth to act at home and in their community, build community trust and partnerships.
- **Transportation Actions:** Transition to 100% zero emissions transportation and expand supporting infrastructure, public transit, reduce use of personal automobiles, and introduce new technologies such as EV charging stations. The placement of EV charging stations in parking lots which are remote from the buildings will become a utility master planning issue. Decisions will need to be made on the location, costs, access and who is responsible for paying for the use of the electricity.

**Update History**

Original Issue Date: July 5, 2022  
BKM No. 19021.01

Updated No.	Date	Revised By	Section Revised	Update Notes

---

## Table of Contents

---

Executive Summary .....	1
Domestic / Fire Water System .....	7
Sanitary Sewer System .....	8
Storm Drainage System .....	9
Natural Gas System .....	11
Mechanical Systems .....	12
Electrical Systems .....	23
Appendix 1 – General Information .....	TAB 1

Table 1-1 – Building Abbreviations List

Table 1-2 – List of Abbreviations

Table 1-3 – Campus Long-Term Facilities Masterplan Timeline

Drawing C1.01 – Composite Site Plan – Existing Conditions

Drawing C1.02 – Composite Site Plan – Near-Term Future Conditions (2022-2034)

Drawing C1.03 – Composite Site Plan – Long-Term Future Conditions (2035-Beyond)

Appendix 2 – Plumbing Systems .....	TAB 2
-------------------------------------	-------

Drawing P1.01 – Site Plan – Water System – Existing Conditions

Drawing P1.02 – Site Plan – Water System – Near-Term Future Conditions (2022-2034)

Drawing P1.03 – Site Plan – Water System – Long-Term Future Conditions (2035-Beyond)  
Drawing P1.11 – Site Plan – Sanitary System – Existing Conditions  
Drawing P1.12 – Site Plan – Sanitary System – Near-Term Future Conditions (2022-2034)  
Drawing P1.13 – Site Plan – Sanitary System – Long-Term Future Conditions (2035-Beyond)  
Drawing P1.21 – Site Plan – Storm System – Existing Conditions  
Drawing P1.22 – Site Plan – Storm System – Near-Term Future Conditions (2022-2034)  
Drawing P1.23 – Site Plan – Storm System – Long-Term Future Conditions (2035-Beyond)  
Drawing P1.31 – Site Plan – Natural Gas – Existing Conditions  
Drawing P1.32 – Site Plan – Natural Gas – Near-Term Future Conditions (2022-2034)  
Drawing P1.33 – Site Plan – Natural Gas – Long-Term Future Conditions (2035-Beyond)

Appendix 3 – Mechanical Systems ..... TAB 3

Table 3-1 – Cooling/Heating Loads – Existing Buildings  
Table 3-2 – Cooling/Heating Loads – Near-Term Future Buildings (2022-2034)  
Table 3-3 – Cooling/Heating Loads – Long-Term Future Buildings (2035-Beyond)  
Table 3-4 – Cooling Plants – Existing Equipment  
Table 3-5 – Heating Plants – Existing Equipment  
Chart 3-1 – Campus Cooling Loads vs Cooling Capacity  
Chart 3-2 – Campus Heating Loads vs Heating Capacity  
Drawing M1.01 – Site Plan – Chilled Water – Existing Conditions  
Drawing M1.02 – Site Plan – Chilled Water – Near-Term Future Conditions (2022-2034)  
Drawing M1.03 – Site Plan – Chilled Water – Long-Term Future Conditions (2035-Beyond)  
Drawing M1.11 – Site Plan – Heating Water – Existing Conditions  
Drawing M1.12 – Site Plan – Heating Water – Near-Term Future Conditions (2022-2034)  
Drawing M1.13 – Site Plan – Heating Water – Long-Term Future Conditions (2035-Beyond)  
Drawing M2.01 – Schematic – Campus Chilled Water – Existing Conditions  
Drawing M2.02 – Schematic – Campus Chilled Water – Near-Term Future Conditions (2022-2034)  
Drawing M2.11 – Schematic – Campus Heating Water – Existing Conditions  
Drawing M2.12 – Schematic – Campus Heating Water – Near-Term Future Conditions (2022-2034)  
Drawing M3.01 – Schematic – Bioscience Education Central Plant (BE) – Existing Conditions  
Drawing M3.02 – Schematic – High Technology and Science Center Central Plant (HT) – Existing Conditions  
Drawing M3.11 – Schematic – Bioscience Education Central Plant (BE) – Existing Conditions  
Drawing M3.12 – Schematic – High Technology and Science Center Central Plant (HT) – Existing Conditions  
Drawing M3.13 – Schematic – Humanities (HS) Satellite Plant (HS) – Existing Conditions

Drawing M4.01 – Equipment Plan – Bioscience Education Central Plant (BE) – Existing Conditions  
Drawing M4.02 – Equipment Plan – High Technology and Science Center Central Plant (HT) – Existing Conditions  
Drawing M5.01 – Typical Building Connection Details

Appendix 4 – Electrical Systems..... TAB 4

Table 4-1 – Electrical Loads – Existing Buildings  
Table 4-2 – Electrical Loads – Future Buildings  
Table 4-3 – Photovoltaic System – Near-term Future Buildings  
Drawing E1.01 – Site Plan – Power – Existing Conditions  
Drawing E1.02 – Site Plan – Power – Near-term Future Conditions (2022-2034)  
Drawing E1.03 – Site Plan – Power – Long-term Future Conditions (2035-Beyond)  
Drawing E1.04 – Site Plan – Potential Photovoltaic Locations  
Drawing E1.05 – Site Plan – Power – Near-term Future – New North Loop  
Drawing E1.06 – Site Plan – Power – Near-term Future – New South Loop  
Drawing E2.01 – Single Line Diagram – Power – Existing Conditions  
Drawing E2.02 – Single Line Diagram – Power – Long-Term Future Conditions

Appendix 5 – Montgomery College Provided Information..... TAB 5

Power Metering Charts

## EXECUTIVE SUMMARY

Burdette, Koehler, Murphy & Associates, Inc. (BKM) was retained by Montgomery College (MC) to provide new Utilities Master Plans (UMP) for the Germantown (GT), Rockville Campus (RV), and Takoma Park/Silver Spring (TP/SS) campuses. The following Utility Master Plan report focuses on the Germantown Campus. The Germantown Campus is located northeast of Interstate 270 in Germantown, MD. The campus is buffered by forest conservation easement to the south and northeast. The College property is bounded to the west by I-270 and route 118, Hughes Property to the south, Middlebrook Road to the south and properties to the east. The northern entrance to campus at Germantown Road is lined with outdoor sports facilities and a small stormwater pond. The campus currently consists of nine buildings, Bioscience Education Center (BE), Child Care Center (CG), Humanities and Social Sciences (HS), Dr. DeRionne P. Pollard Student Affairs and Science Building (SA), High Technology and Science Center (HT), Physical Education (PG), Greenhouse (GN), Vehicle Maintenance Shop and Paul Peck Academic & Innovation Building (PK). For the purposes of this study the Paul Peck, Vehicle Maintenance Shop and Greenhouse buildings will be described but not evaluated as they are expected to remain in operation as stand-alone buildings, not connected to the campus utilities. A campus map is provided at the end of the Executive Summary.

Located on the College's property to the south of the Montgomery College: Germantown campus sits the Holy Cross Germantown Hospital campus. The hospital leases this site from the College. There are several parcels of property south of Observation Drive that are College property but under the management of Montgomery College Pinkney Innovation Complex (MCPIC). This property is slated for Public Private Partnerships (P3) and bioscience targeted development but do not generally fall under the umbrella of the utility master plan. The exception to this is when the proposed development encroaches on UMP infrastructure or when the development triggers building codes under the jurisdiction of the College.

The goal of this report is to document capacity of the central cooling and heating systems, plumbing systems (domestic cold water, stormwater, sanitary sewer and natural gas) and electrical systems that serve the GT Campus in regards to future expansions outlined in the 2013-2023 Facilities Master Plan produced by Cho Benn Holback & Associates. The emphasis of this study is on the existing campus, central plants and construction of the new Student Services Center. Both the generation and distribution systems of the utilities were evaluated in this study and recommendations are provided to satisfy the campus future requirements. The UMP has been divided into three timelines to provide appropriate planning and documentation for the existing, near-term (2022-2034) and long-term (2035-beyond). A summary of "near-term" planned campus additions and renovations include:

- New construction of the (153,660 GSF) Student Services Center (SD).
- Phase 2 renovation of Dr. DeRionne P. Pollard Student Affairs and Science Building (SA), including demolition of wing and addition to include an additional 18,600 GSF to bring the building total to 118,248 GSF.

Numerous additional changes to the Germantown campus have been identified in the Facilities Master Plan, but have been determined to be a part of the long-term future of the campus as their projected timeline are beyond 2034. These planned campus projects include:

- Renovation of Humanities & Social Sciences (HS).
- New construction of (34,200 GSF) Science/Math/Science Buildings.
- New construction of (72,000 GSF) Arts & Communication Building.

- Renovation of the existing High Technology & Science Building (HT).
- Renovation and 36,500 GSF addition to the existing Physical Education Building (PG).
- Renovation of the existing stand-alone Paul Peck Academic & Innovation Building (PK).

This utilities master plan (UMP) will provide an update to previous utilities master plans to document existing conditions in addition to utility planning based on the current Facilities Master Plan and its known updates. An overview of equipment documentation, significant findings and recommendations will be detailed in individual sections which includes analysis of the existing and future projected requirements for heating, cooling, and electrical distribution systems. The UMP also documents the existing site utilities of domestic/fire water, sanitary sewer, stormwater drainage and natural gas and their proximity to future building footprints. A summary of building abbreviations and a timeline for buildings existing in 2022 and for the proposed future campus can be found in Appendix 1.

### **Domestic Water, Sanitary Sewer, Stormwater and Natural Gas**

The domestic cold water, sanitary sewer, stormwater and natural gas systems were reviewed as part of this study. The main focus of this study with relation to the plumbing systems is identification of conflicts with existing utilities and the footprints of future buildings. The analysis of any existing or future capacities has been documented based on the previous 2013 UMP, and is understood to remain accurate for the purposes of this study.

The combined domestic/fire water system on campus is supplied and serviced by the Washington Suburban Sanitary Commission (WSSC). A single master WSSC revenue meter serves the campus and is located in a vault adjacent to the vehicle shops building. All campus buildings are served by combination incoming underground domestic water piping which splits between fire protection piping and domestic water piping in an incoming service mechanical room. Individual meters are installed to each building, which are owned by the college and used for monitoring purposes only. Additional submeters are recommended for all building domestic water services as well as any cooling tower makeup, makeup water connections to chilled and heating water systems, playing field watering, water used by greenhouses, and pool system makeup connections. These submeters should be monitored and tracked by the campus energy management and control system (EMCS) to reduce utility sewer charges and help Montgomery College staff to identify/troubleshoot system problems. The WSSC system is capable of providing the existing and future flow rates required for domestic water usage and fire flow rate requirements. Since the 2013 UMP update, a 24" WSSC water main has been relocated due to the construction of the BE building. A 12" water main is routed along Observation Drive, south of the BE building and loops back around to create a distribution loop for the campus. The existing 12" loop avoids the footprint of future buildings planned for campus. The only anticipated modification to the WSSC piping on campus would be the relocation of incoming 12" piping main from Germantown Road which will need to be relocated to avoid a new building and parking garage anticipated as part of the long-term facilities master plan for the campus. Refer to Drawing P1.01 in Appendix 2 for the location of the existing water mains located under the existing roadways.

The campus sanitary system discharges into the WSSC sewer system via collector pipes located throughout campus. The existing collector lines are adequately sized for the current building capacity. New collector lines will be installed or replaced as new buildings are construction on campus. The existing sanitary lines will need to be relocated to avoid conflicts with future building footprints.



The Germantown campus covers approximately 230 acres, consisting of grass, woods, buildings and open parking lots. The northern portion of the campus utilizes inlets and pipes from campus to drain into a stormwater pond. The southern part of campus including the area surrounding the BE and SA buildings and southeast parking lot drain to inlets and stormwater structures that then discharge to a 42” pipe that drains south away from campus. The current stormwater pond and drainage pipe are believed to be sufficient for existing and future conditions. The addition of future buildings will require re-routing, extending and new inlets to provide adequate stormwater drainage for the campus.

Natural gas is currently distributed to a majority of the buildings on campus by Washington Gas (WGL). A 4” underground pipe distributes gas to buildings and remains clear of any future building footprints.

It is recommended that the existing campus metering be expanded to include major uses of water, sanitary sewer, and natural gas. These meters should be integrated with the EMCS and be implemented in a manner that complies with MC’s new Building Energy Performance Standards. This expanded metering will help facilities staff identify and diagnose maintenance issues as they arise on these systems. It will also help MC comply with Montgomery County’s new benchmarking law.

The plumbing systems will be further described in a later section of this study along with site plans located in Appendix 2 of this study to reference the location of existing systems.

## **Mechanical Systems**

The campus heating and cooling utilities are centrally located in two buildings the Bioscience Education Building (BE) and the High Technology and Science Center (HT). The HT central plant was built in 1995 and provides a central chilled water system for the campus. The HT central plant boilers were installed to support the HT building locally. Satellite boilers in the HS provide heating water to the HS and PG buildings. The current renovation of the SA building has removed local boilers from the mechanical room. In 2013, the BE building and BE central plant were constructed to increase the campus heating and chilled water generation capacities. An underground chilled water distribution system connects the BE and HT plants with an underground vault with isolation valves, and then distributes chilled water through direct-buried piping to the CG, HS, HT, BE and SA buildings. Piping to PG has been extended to the edge of the building in a HVAC vault for future connection. The BE plant distributes heating water to support the BE Building, the renovated SA building and the Child Care Center (CG). The BE central plant heating water piping has been extended towards the northern campus buildings for a future tie-in to the HT & HS heating water systems.

Due to central plant capacity and piping configuration deficiencies within the HT plant a renovation to the existing plant is expected by Fall 2027, to maximize and optimize its capacity. The timeline for these upgrades is independent to the construction of the Student Services Center which is anticipated to be occupied by 2029. A future SD satellite plant should provide sufficient building heating and cooling for itself, upgrades to the HT plant and connection of the new building to the existing campus distribution piping will provide additional redundancy and capacity to the existing system and allow the SD building to utilize the ice thermal storage capabilities of the HT & BE central cooling plants.

The BE central plant is located in the basement of the BE building. The BE plant consists of condensing boilers and primary pumps for heating water distribution and chillers, cooling towers, ice thermal storage tanks and primary pumps for chilled water distribution. The heating water is distributed through underground piping to the SA and CG buildings. Chilled water is distributed from the BE central plant to SA, CG and connects to the northern section of underground chilled water piping at an HVAC vault. At this time, the BE and HT chilled water plants remain isolated from each other and provide cooling for their respective connected buildings. The heating water and chilled water central plant

capacities connected to the BE central plant are believed to be sufficient for the existing buildings in addition to a 50,000 gross square foot unspecific building to be located at the southeast portion of campus. With future buildings planned for the southern half of campus, distribution piping will need to be extended from the existing piping stubs within the existing underground vault along with providing additional capacity in the existing HT central plant to provide adequate future capacity for the campus.

The High Technology (HT) central plant is located on the first floor of the HT building. The HT plant includes older chilled water equipment and recently installed local condensing boilers. The chilled water piping and plant capacities have been studied several times over the past few years to determine the best course of action for correcting challenging valve sequences along with unbalanced equipment capacities. Modifications have been made to optimize controls, but additional modifications are expected during future projects. The differences in capacity between existing equipment limit the chilled water plant capacities in lieu of optimizing all equipment capacities. Ammonia chillers, a cooling tower, outdoor ice storage modules and primary chilled water pumps are installed to operate the HT central plant. Chilled water is distributed from the HT central plant to HS and a vault to serve a future extension to the PG building. As previously mentioned, the two central plants are connected via chilled water piping in an underground vault but have been remained isolated. Upgrades and equipment replacement are expected for the HT central plant to replace aging equipment, improve operation and increase overall capacity of the existing plant.

Additionally, it is recommended that campus domestic hot water and pool heating systems be evaluated for possible removal from the central heating water system. If these systems are removed, the central heating water system may see an increase in overall efficiency due to reduced return water temperature at the condensing boilers. To accommodate this, local boilers/water heaters will be needed in each building with a domestic hot water and pool heating requirements.

It is recommended that the existing campus metering be expanded to include major uses of chilled and heating water. These meters should be integrated with the EMCS and be implemented in a manner that complies with MC's new Building Energy Performance Standards. This expanded metering will help facilities staff identify and diagnose maintenance issues as they arise on these systems. It will also help MC comply with Montgomery County's new benchmarking law.

## Electrical Systems

The campus is served by the Potomac Electric Power Company (PEPCO) from an underground distribution line owned by the utility. The service is an underground loop 13.2kV feeder, originating at a PEPCO overhead line feeder 14880, which enters the campus near the intersection of MD Route 118 and Goldenrod Lane. A second PEPCO feeder, 14889, interconnects with the campus along MD Route 118. Most buildings are served by pad-mounted transformers fed by the 13.2kV underground distribution loop.

Removal of the existing buildings and the following new construction projects shall be coordinated with PEPCO. Projected load estimates for the new buildings shall be provided to PEPCO in order to determine if the existing PEPCO owned electrical distribution infrastructure has sufficient capacity for the new loads. PEPCO will need to design and approve of campus electrical distribution system modifications. The College would then be responsible for reimbursing construction costs to PEPCO.

Please note that PEPCO has not provided detailed information to date regarding the construction of future buildings as it relates to the impact to existing PEPCO primary feeders and associated infrastructure. Load information on campus load

growth has been provided to PEPCO and through the efforts of key College personnel, requests for information from PEPCO are ongoing.

The electrical systems will be further described in a later section of this study along with site plans and one-line diagrams located in Appendix 4 of this study.

# MONTGOMERY COLLEGE

Germantown Campus | Pinkney Innovation Complex for Science and Technology (PIC MC)

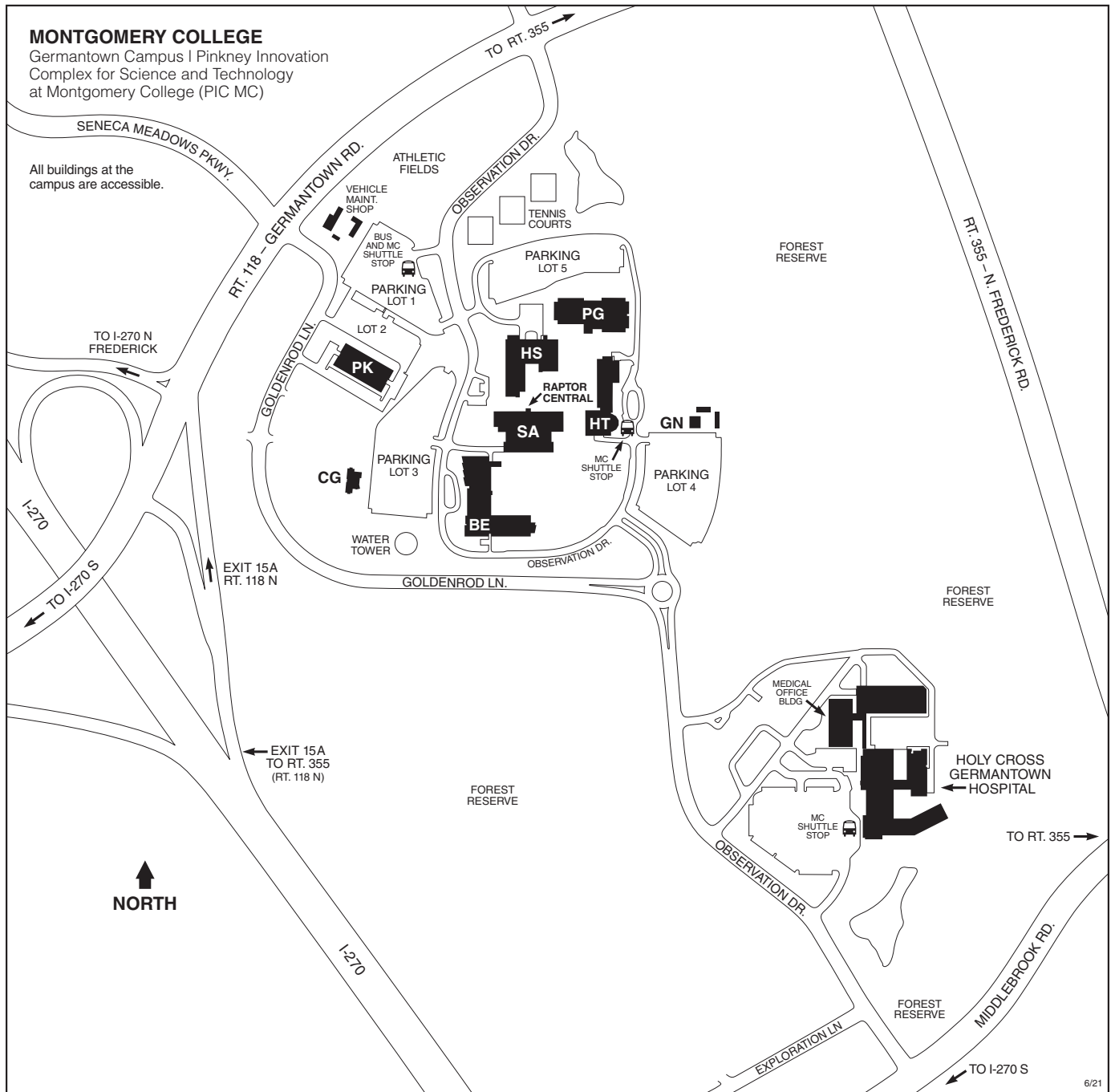

**MC MONTGOMERY COLLEGE**  
Germantown Campus | Pinkney Innovation Complex for Science and Technology at Montgomery College (PIC MC)  
20200 Observation Drive  
Germantown, MD 20876  
240-567-7711  
Public Safety: 240-567-3333 (24/7)  
montgomerycollege.edu/safety  
montgomerycollege.edu/maps

## Legend of Campus Buildings

(as of June 2021)

- BE** Bioscience Education Center
  - Conference Center
- CG** Child Care Center
  - Center for Early Education (CEE)
- GN** Greenhouse

- HS** Humanities and Social Sciences Building
  - Bookstore
  - Cafeteria
  - Library
  - Workforce Development and Continuing Education (WDCE)
- HT** High Technology and Science Center
  - Globe Hall
- PG** Physical Education Building

- PK** Paul Peck Academic and Innovation Building
  - Germantown Innovation Center
- SA** Dr. DeRionne P. Pollard Student Affairs and Science Building
  - Counseling and Advising
  - Disability Support Services
  - Financial Aid Office
  - Public Safety Office
  - Raptor Central (Admissions, Enrollment, Visitor Services)
  - Records and Registration Office
  - Student Life Office

## **DOMESTIC/FIRE WATER SYSTEM**

### **Scope**

The Germantown (GT) campus utilities master plan provides an evaluation of the existing and future water system capacities based on the Facilities Master Plan 2013-2023. The campus receives domestic and fire protection water from the Washington Suburban Sanitary Commission (WSSC). A single master WSSC water meter serves the campus. The GT campus buildings are individually metered by Montgomery College for monitoring purposes. Montgomery College owns, maintains and operates the domestic water system downstream of the WSSC meter. Drawing P1.01 in Appendix 2 shows a site plan of the existing domestic water distribution piping.

### **Existing Conditions**

Each building is served by combination underground domestic/fire water piping. All of the sprinklered buildings on campus have a branch of the incoming water piping with a backflow preventor. Domestic water is individually metered in each building for monitoring purposes by Montgomery College. The WSSC distribution system is currently able to meet the campus required capacities. Previous studies indicate that the Germantown campus is served from the Brink Road Elevated Tank approximately two miles from campus. A 12” underground pipe provides incoming water to campus via Germantown Road with a vault and meter within the Germantown campus property. The 12” pipe routes to the north and south around the campus buildings to create a distribution loop. The original portions of this distribution loop were installed between 1978 and 1983, with additions in 1995 and the final portion of the loop being completed in 2013. A WSSC water tank is located on campus, and had not previously been connected to serve the campus. A new 12” connection with a vault and meter to the on campus WSSC tank has been made and extends to the existing 12” pipe routed along Observation Drive. It is unknown if this valve is open to campus.

### **Previous Master Plan**

The 2013 UMP by Wiley|Wilson provided an explanation that previous utilities master plans had analyzed the peak day, hour and fire flow demands for the present and future campus. The analysis indicated that the WSSC distribution system would provide enough water for existing and future peak domestic water demands of the GT campus. The previous master plan provided recommendations for extending or relocating domestic water piping for future buildings which has been updated for this study.

### **Future System Requirements**

The existing water distribution system is adequate to provide the required flow for the planned new buildings on campus and will be modified from the distribution piping location under the public roads adjacent to campus. As renovations are completed within existing buildings and new buildings are built, new incoming water meters are to be installed including sub-meters within future or existing heating or cooling plants to monitor make-up water usage.

### **Summary and Recommendations**

The existing WSSC system is capable of providing adequate domestic water capacity to the existing and future buildings listed in the facilities master plan. Modifications to the existing distribution system will be made as required to extend branch piping to new buildings or additions to existing buildings.

## **SANITARY SEWER SYSTEM**

### **Scope**

The 2022 UMP provides documentation of the existing and future sanitary sewer system at the Germantown campus based on the Facilities Master Plan 2013-2023. Montgomery College owns and maintains its campus collection system and discharges to the Washington Suburban Sanitary Commission (WSSC) sewer system. Drawing P1.02 in Appendix 2 shows a site plan of the existing sanitary collection piping.

### **Existing Conditions**

The existing sanitary sewer system consists of sanitary collector pipes that receive discharge from the building collection lines. These collection pipes then flow into the WSSC collection system along Observation Drive and out the southern entrance of campus. The existing sanitary lines can be found on Drawing P1.02. The existing sewer collection system is believed to be adequate for campus flows per the previous utilities master plans.

### **Previous Master Plan**

Per the previous utilities master plan the existing sanitary sewer system has adequate capacity for the existing campus discharge as well as for the future campus flows. It was noted to future building footprints of a student services building and art building will conflict with an existing 8" line that is routed across the west to northeast corner of campus. While the footprint of these future buildings has been modified slightly by the recent facilities master plan the future conflict still remains and is included in the future system requirements and recommendations.

### **Future System Requirements**

As previously mentioned, the existing WSSC sewer system is believed to be adequate to serve the future campus buildings. Modifications to the on-campus collection lines will be required to new campus buildings. This will include re-alignment of an existing 8" sanitary sewer line routed from the west side of campus out through the northeast property line. The rerouting of these sanitary discharge lines included in the design of the future building, including new collection lines from the new buildings. Any future renovations and additions should include new collection lines or modification of existing collection lines that drain into the WSSC sewer system located in the adjacent roadways to campus to meet additional sanitary capacity requirements.

### **Summary and Recommendations**

The campus sanitary system discharges into the WSSC sewer system through collector pipes through campus. The existing collector lines are adequately sized for the current building capacity. New collector lines will be installed or replaced as buildings are renovated and future buildings are constructed. A significant portion of an existing 8" sanitary line will require relocation for the construction of the SD building as well as a future long-term building on the north portion of campus. It is expected that existing WSSC sewer system will be adequate for the future buildings on the Germantown campus.

## **STORM DRAINAGE SYSTEM**

### **Scope**

The 2022 UMP provides documentation of the existing and future storm water system at the Germantown campus based on the Facilities Master Plan 2013-2023. Drawing P1.03 in Appendix 2 shows a site plan of the existing stormwater drainage system.

### **Existing Conditions**

The existing stormwater drainage system on campus consists of inlets, pipes and a stormwater pond. The existing stormwater system is believed to be adequate to serve the campuses current and future capacities.

### **Previous Master Plan**

The 2006 utilities master plan completed a comprehensive analysis of the stormwater drainage system. The report indicated that the some of the campus drainage piping may be undersized based on storm modeling. The study elaborates that this type of modeling is inexact science and that no flooding issues have been identified on campus. Recommendations for these deficiencies were included in the 2013 utilities master plan by Wiley | Wilson, but were not considered to be imminent due to no known issues. Facilities on the east campus would need to be corrected due to the low permeability rates of the surrounding soils. The 2006 report indicated that no flooding issues were found on the west campus. The report does recommend that future stormwater management facilities may be required to meet state stormwater management requirements.

### **Future System Requirements**

The recommendations from 2013 UMP still apply for future construction including additions, renovation and new construction. As construction take place on campus the existing storm lines will need to be adjusted and new systems to be installed to accommodate the new building or additions. The construction of the new SD building adjacent to the PG building will require an existing 36" storm line to be realigned with the new building footprint and allow for proper drainage to the stormwater pond. All new stormwater lines should discharge to the existing stormwater pond or be provided with new stormwater management facilities appropriately sized based on state and local regulations for quantity and quality.

### **Summary and Recommendations**

The stormwater drainage is adequately sized to accommodate planned campus construction including new buildings and building additions. While the 2006 stormwater model identified potential deficiencies the campus has not experienced any flooding issues. The existing 36" storm line that discharges into the stormwater pond will need to be relocated as part of construction to build the new Student Services Center. As buildings are built or modified on campus the existing storm inlets and drainage lines will need to be added or modified to connecting to the new system. It is recommended that all new stormwater lines discharge into the existing stormwater pond. For those runoff areas that do not drain into the existing pond new stormwater management facilities they will likely need to utilize bio-retention areas to meet current state and local requirements, for more natural quantity and quality controls areas. Although the previous UMP indicated that the stormwater system is adequate to serve the campus stormwater runoff, climate change continues to impact local weather and, therefore, system sizing and capacity should be evaluated with each new

construction project. If climate change continues in this fashion, stormwater drainage system resiliency will be vital to protecting to existing and future buildings, infrastructure, and people. Future projects should consider green roofs and additional bio-retention areas to increase campus stormwater drainage system capacity and resiliency. Storm water drainage pipe infrastructure should be evaluated with each new construction project to ensure the sizing remains adequate for changing campus layout and local weather patterns.



## **NATURAL GAS SYSTEM (NG)**

### **Scope**

The 2022 UMP provides documentation of the existing and future natural gas (NG) system at the Germantown campus based on the 2013-23 facilities master plan. Drawing P1.04 in Appendix 2 shows a site plan of the existing natural gas distribution system.

### **Existing Conditions**

Natural gas is currently distributed to the BE, SA, GH, HT, HS and PK buildings on campus by Washington Gas (WGL). A 4” underground pipe distributes gas to buildings and remains clear of any future building footprints. The piping is distributed around the perimeter of campus to each building with individual meters at the building.

### **Previous Master Plan**

The 2013 utilities master plan completed an analysis of the existing natural gas distribution piping and determined that the existing piping is adequately sized for the existing and future conditions of campus. During the BE building construction the natural gas main was re-routed to serve BE and then back north to reconnect to the existing piping main.

### **Future System Requirements**

The recommendations from 2013 UMP still apply for future construction including additions, renovation and new construction. As construction take place on campus the existing natural gas piping will need to be adjusted and new branches will be installed to accommodate the new building or additions. The current footprints of future buildings do not conflict with the current routing of the gas piping, but this should be re-evaluated if the footprint of a building or renovation changes. It is expected natural gas will continue to be Montgomery College’s heat generating source for future satellite plants and existing central plants due to the cost of conversions and utility rates. Additionally, this conversion would require upgrades to the electrical infrastructure. As future buildings are constructed this decision should be reviewed to meet MC’s sustainability goals.

### **Summary and Recommendations**

Based on previous UMP’s the natural gas distribution is believed to be adequately sized to accommodate planned campus construction including new buildings and building additions. As buildings are built or renovated on campus the existing natural gas piping will need to be extended connect to the new building.

While Montgomery County Government’s current climate action plan recommends future building electrification and elimination of natural gas, this recommendation conflicts with the overall recommendations of the UMP, as a main utility source for all current and future heating plants. Additionally, removal from natural gas from the Germantown Campus would eliminate any opportunity for a combined heat and power plant, and therefore further restricting the use of a micro-grid for campus resiliency and a potential redundant power source for the hospital on campus. Due to the current cost benefits of natural gas usage over electricity and the capital cost to convert current infrastructure for use of electric it is expected that the Germantown Campus continues to use natural gas into the near-term future.

## **MECHANICAL SYSTEMS – CHILLED WATER**

### **Scope**

The 2022 UMP provides documentation, analysis and recommendations of the existing and future chilled water systems at the Germantown campus based on the Facilities Master Plan 2013-2023. This study documents the existing equipment and capacities of the installed mechanical equipment in the central plants as well as the demand load for cooling of each building. The study also provides recommendations to improve performance of the existing systems and distribution piping along with modifications that are required as buildings are constructed or renovated. Drawing M1.01 in Appendix 3 shows a site plan of the existing chilled water system. Drawing M1.02 in Appendix 3 shows a site plan of the near-term chilled water system. Drawing M1.03 in Appendix 3 shows a site plan of the long-term chilled water system. Additionally, part plan schematics are referenced to indicate the central plant piping configurations.

### **Existing Conditions**

The Germantown campus is separated into two central cooling plants. Each plant currently supports part of the campus with interconnecting chilled water piping connecting the two plants. Both central plants, are constructed with ammonia chillers, primary glycol chilled water piping, ice thermal storage, cooling towers and a glycol to chilled water heat exchanger.

The south portion of campus is served by a central plant located in the basement of the Bioscience Education Center (BE) and the northern portion of campus central plant is located on the first floor of the High Technology and Science Center (HT). Underground insulated piping connects between two underground HVAC vaults with isolation valves for shutoff between the systems. While the connection between the systems was made several years ago during the construction of the BE central plant, the valves have not been regularly opened to allow the two central plants to operate in conjunction. As the isolation valves have remained normally closed in the HVAC vault, the two central cooling plants in HT and BE operate as two separate systems and provide cooling to their associated branches, respectively.

The BE central plant was constructed in 2013 as a part of the new Bioscience Education Center building. The cooling central plant is located in the basement of the state-of-art building. Two (2) Frick 338 ton ammonia chillers and a single 360 ton Daikin-McQuay electric magnetic bearing water-cooled chiller provide the cooling to the chilled water system. The two ammonia chillers utilize glycol chilled water for ice production at 250 ton per hour per chiller during off-peak hours. Located in the basement are eight (8) BAC ice storage modules each capable of storing 761 tons-hours of cooling for a total of 6,088 tons-hours of storage. Based on the typical eight hours of night-time ice building the two ammonia chillers are only capable of filling 4,000 ton-hours of the 6,088 ton-hours overall capacity. Two (2) 775 ton induced draft BAC cooling towers with variable frequency drives are located on the roof to reject heat from the cooling plant. The cooling towers include a Lakos side stream basin sweeper system to filter the condenser water. The BE plant is capable of providing 1,112 tons of cooling to campus by use of ice-melt and chiller operation during peak cooling hours. The glycol chilled water utilizes a plate and frame heat exchanger to transfer heat between the campus chilled water loop and the central plant glycol loop. The campus chilled water is then distributed to campus by two (2) 40 horsepower Bell & Gossett pumps delivering 834 gallons per minute (gpm) of chilled water each. The chilled water exits the central plant below grade through a 10" supply and return piping to create a distribution header to campus. The underground Perma-Pipe distribution piping wraps around the south of the BE building and continues north along the east side of the SA building. Prior to the SA building a HVAC vault provides a connection for a future 50,000 GSF building and a branch to serve the SA and CG buildings. The branch piping to SA has been rerouted as part of the recent SA renovation to enter the SA building, with a branch to serve the SA building and continue on and back out to

campus across the existing west parking lot to the Child Care Center (CG). A vault located between CG & PK provides a future connection to PK with limited future capacity. As is typical for all campus buildings, a set of chilled water building pumps downstream of the typical piping bridge distribute chilled water to the building.

The HT central plant was constructed in 1995 as a part of the construction of the High Technology and Science (HT) building. The cooling central plant is located on the first floor of the building. Two (2) Frick 265 ton ammonia chillers provide the cooling to the chilled water system. The original chiller was installed during 1995 and the second standby ammonia chiller was installed in 1999. The two ammonia chillers are capable of operating in four separate modes, ice build, ice melt, ice melt & chiller operation and chiller only. During the ice-build mode a single chiller is capable of 220 tons per hour by utilizing glycol chilled water for ice production during off-peak hours. Located adjacent to HT and across the lane to the central plant are two (2) BAC ice storage modules located outdoors each capable of storing 1,220 tons-hours of cooling for a total of 2,440 tons-hours of storage. A single 340 ton induced draft BAC cooling tower with variable frequency drive is located next to the ice storage modules in a fenced in equipment yard. The cooling tower includes a side stream basin sweeper system to filter the condenser water. The HT plant is only capable of providing 570 tons of cooling to campus by use of ice-melt and chiller operation during peak cooling hours, due to limitations of the existing equipment. The current operation of the HT cooling plant only allows for a single chiller to operate at a time, limiting the overall ice-building capacities and cooling capacity of the chilled water system. The limitations of operating a single chiller are due to the size of the single cooling tower which limits the heat rejection of the system. Additional ice storage space is present and originally planned for but has not been installed to date, thus the HT plant has not been expanded to its total potential capacity. During a typical 8-hour ice-building period, which normally operates from 8:00 pm to 4:00 am, the maximum of latent cooling to be generated is 1,760 tons, which does not maximize the storage capacity of the two existing ice storage tanks. Space is available for an additional cooling tower and two additional ice storage tanks, and investigation has been completed to design additional capacity for the outdoor equipment. The existing plate and frame heat exchanger is adequately sized for a single chiller, which would require a second or replacement heat exchanger for the cooling plant capacity to increase. In addition to the equipment sizing inadequacies, the piping within the cooling plant prevents the plant from reaching its full capacity. Due to these issues with the plant piping arrangement and valve operation the plant will need to undergo changes in addition to the equipment upgrades to increase the overall capacity of the plant. The glycol chilled water utilizes a plate and frame heat exchanger to transfer heat between the campus chilled water loop and the central plant glycol loop. The campus chilled water is then distributed to campus by two (2) 60 horsepower Bell & Gossett pumps capable of delivering 1,500 gallons per minute (gpm) of chilled water each. The chilled water exits the central plant below grade through a 12" supply and return piping to create a distribution header to campus. The underground chilled water distribution piping from the HT plant is fiber reinforced plastic (FRP) with foamglas insulations and pitwrap jacketing.

The distribution piping exits the central HT plant underground to a HVAC vault where it connects to the 12" supply and return piping from the BE cooling plant. As previously mentioned, these valves have remained closed, isolating the two chilled water systems. The HT campus piping continues north to a HVAC vault which provides a future connection and piping stubs for extension to the PG building. An 8" supply and return piping are then extended to the HS building, where the typical piping bridge decouples the building piping from the campus piping to distribute the chilled water locally through the building with building chilled water pumps.

As cooling demand increases or decreases throughout the day, the building pumps are able to decrease/increase water flows by use of variable frequency drives (VFD) and target an optimal operating setpoint. By calculating a differential pressure at each building due to water usage, the central plant primary pumps ramp up or down by VFD control to meet the campus cooling demand. The detail included in Appendix 3 indicates the typical piping installation and valve

arrangement for each satellite building connection. The attached Table 3-1 provides a summary of the “Existing Cooling Loads” for the buildings on each campus. A table of all the existing plant equipment can be found in Table 3-4.

### Previous Master Plan

Since the previous UMP, the BE central cooling plant has been completed, which added 1,112 tons of cooling capacity to the campus. The chilled water piping has also been extended from SA building to the new CG building and connected to the campus chilled water piping system. This connection included a new vault which could provide limited capacity to the PK building in the future. Another change from the previous UMP was the installation of new underground piping from the BE chilled water plant that extends and connects to the HT plant at an underground HVAC vault. The previous recommendations for the chilled water system reference the addition of the BE central plant as well as correcting the deficiencies mentioned in the existing conditions section.

### Future System Requirements

The future campus cooling requirements have been separated into two timelines to approach the near-term and long-term cooling demands of the Germantown campus. Refer to Table 3-2 and Table 3-3 for the expected building loads. With the new Student Services Center to be constructed by 2029, and renovations of the SA and HS buildings in 2031 and 2039 respectively, new cooling demand will be added to the campus connected load. While SA & HS currently utilize water-source heat pumps, future renovations would be expected to include central air handling units connected to the chilled water system, reducing the compressor load heat rejection to the campus chilled water system. This is dependent of future occupancy of the buildings and final system selection. For the near-term operation of the campus to support the new building and renovation projects, the existing HT plant should need to be upgraded to correct existing limitations and add cooling capacity and redundancy to the plant and campus.

The existing campus connected chilled water load is estimated to be 1,717 tons, and the existing plant capacity is 1,682 tons of cooling. The first major milestone of the near-term future (2022-2034) is the completion of the new Student Services (SD) Center in 2029. The new connected load is expected to reach 2,231 tons of cooling demand, which could increase depending on the final square footage of the Student Services Center building. As the PG building currently operates through use of direction expansion (DX) equipment it is expected that in the near-term the existing chilled water piping stubs are extended into the building and connected to new HVAC equipment. This new campus connected load will create a shortage of cooling when compared with the campus peak load and plant capacity.

Due to the current capacity limitations of the existing equipment mentioned in the previous existing conditions sections of the HT plant, an upgrade is recommended to be completed prior to the completion of the new SD building in 2029. The new capacity of the plant should maximize the existing 12” underground chilled water distribution piping, the existing ammonia chillers and make use of the additional space available for cooling towers and ice storage modules in the outdoor equipment yard. The equipment yard would be renovated to replace the existing cooling tower and original ice thermal storage units to match existing capacities. The installation of a new 375 ton cooling tower and additional thermal storage units will provide the plant with the additional heat rejection capacity required to operate both of the ammonia chillers and increase the overall capacity of the cooling plant. An additional heat exchanger should also be installed to increase the plant capacity to 1140 tons of cooling. As part of additional upgrades to the HT chilled water plant, the existing piping valves, and condenser water pumps to the heat exchanger and ice storage tank can be reworked to provide automated valves and simpler changeover between chiller mode operations. Additionally, it is anticipated that the new condenser water pumps would be provided and located in a new pump house adjacent to the cooling towers in the equipment yard to meet the new capacity of the cooling towers. The existing chilled water pumps

are capable of pumping 1,500 gpm of chilled water to campus, but with the increased plant capacity the pumps should be verified if they are able to operate in parallel to pump the new peak capacity of 2,280 gpm based on a 12°F water temperature operating differential. If the pumps are capable of meeting the new capacity, they could be re-sequenced to provide additional flow, if not, new pumps should be installed to meet the new flow rate. A new set of pumps should be capable of pumping the new flow rate in parallel at half flow or operating as a single pump with a standby at full flow.

While the increased capacity of HT will help meet the peak cooling demands of the campus, a new satellite chiller, located in SD, will be required to meet off-peak cooling requirements, while the HT and BE ammonia chillers are in their respective ice-build modes. A new electric 515 ton water-cooled chiller will be installed in the new SD building cooling plant along with a rooftop cooling tower to match the chiller capacity. This water-cooled chiller will work in tandem with the BE plant 360 ton chiller to meet the campus' off-peak cooling loads while the BE and HT ammonia chillers are working in ice-build modes to fill the ice storage modules in both plants. This will increase the firm capacity of the off-peak cooling if one of the electric chillers went offline for maintenance. The new chiller in the SD building should be sized to provide stand-alone cooling to the building if required, and installed with primary campus distribution pumps to provide the campus with additional chilled water cooling capacity. The SD building should also include secondary or building distribution pumps with a typical decoupler piping detail as shown in Appendix 3 in Drawing M5.01. The building will be connected by high performance underground piping into the existing 8" supply and return piping routed between the PG and HS buildings. A new HVAC vault will be placed underground to provide isolation between the HS and new SD building for future maintenance.

The other change to the campus' chilled water demand in the near-future (2022-2034) is the expected extension and renovation of the PG building to begin utilizing chilled water. An existing HVAC vault with chilled water piping stubs should be extended into the building, with a set of new chilled water distribution piping to provide cooling to the building. While a full renovation and addition of the PG building is anticipated in the long-term future, provisions have been made and will likely be extended into the building prior to complete renovation and addition project expected for 2081.

The renovations to the HT plant and new satellite chiller in the new SD building will provide sufficient cooling capacity for the near term and into the future as well. Looking towards the long-term future additional buildings are expected to be constructed in addition to building upgrades and additions. At this time based on the long term recommendations of the facilities the buildings and renovations planned for the Germantown campus, the plant capacity will be adequate based on a peak cooling load. Previous reports have indicated the campus block loads to total an approximate 75% diversity, which should leave the campus with 25% excess capacity during peak cooling durations. The recommendations for the HT plant and SD satellite chiller plant should allow the campus to increase its overall firm capacity to 1,970 tons, assuming the BE heat exchanger is unable to be utilized. Prior to the design of each new building design and construction the campus cooling requirements should be evaluated to determine the updated connected building cooling demand.

## Summary and Recommendations

The Germantown campus currently has two central cooling plants that provide cooling for the campus. These chilled water plants are located in the HT and BE buildings. The two chilled water plants are interconnected by underground piping, but have remained isolated by shutoff valves in an underground vault. The cooling plants operate independent of each other currently but are capable of providing redundant capacity and chilled water distribution throughout the campus.

The BE cooling plant was completed in 2013, and consists of two (2) ammonia chillers that are used for ice-building during off-peak hours and an electric water-cooled chiller that is used for off-peak cooling and peaking cooling demand durations in conjunction with the ice-melt operation of the cooling plant. The BE chilled water distribution piping currently supplies the BE, SA and CG buildings through underground piping from primary pumps located in the BE building. Each building then utilizes their own set of chilled water pumps for distribution within the building.

The HT cooling plant was built in 1995 and consists of two (2) ammonia chillers that are used for ice building and cooling. A single chiller at a time utilizes outdoor ice storage tanks to build and store ice overnight during off-peak electric usage rates. The chilled water system then melts the ice throughout the day to meet the northern portion of campus with the required cooling demands. The HT cooling plants has several opportunities for upgrades in the future due to the existing configuration and operation of the chilled water system. The installed equipment only provides enough heat rejection and heat exchanger capacity for a single chiller to operate at a time limiting the overall cooling output of the central plant. It is recommended that additional ice storage, an additional cooling tower and heat exchanger are installed to allow both chillers to operate simultaneously and double the plants cooling capacity. At the time of this upgrade the existing cooling tower, ice modules and pumps should be replaced as well. This would maximize the operation of the existing chillers and provide redundancy throughout the campus with additional cooling capacity.

As indicated in the Facilities Master Plan 2013-2023, a new Student Services (SD) building will be the next building constructed on the Germantown campus. The new building should include space for a satellite chiller plant to provide sufficient cooling capacity to meet the buildings cooling requirements. It is recommended that the satellite chiller plant in the SD building is then connected to the existing underground campus chilled water distribution piping. It is recommended that the new chiller be sized to provide enough cooling capacity, an estimated 515 tons, to meet the new load of the building, to allow any upgrades in the HT cooling plant to not be dependent on the construction timeline of the SD building. This would allow the new building to operate independently of the campus system when desired and allow for the extension to the campus piping connection to be deferred, as required. It is recommended that the HT plant upgrades are completed and the new SD building chilled water systems are connected in conjunction with the 2029 building completion date, to provide additional capacity to the campus chilled water system, while maximizing energy savings through the use of ice storage and off-peak energy consumption rates.

Future construction projects beyond the near-term evaluation of this master plan should be re-evaluated to ensure chilled water capacity is adequate for a building construction or renovation. It is recommended that all buildings planned for future construction including the Arts and Communication Building and Math/Science Buildings be connected to the campus chilled water distribution piping. The only exception to this recommendation is depending on funding sources for the Math/Science Center, the entire or parts if the building may need to remain independent from the Germantown central utilities. The Paul Peck (PK) building is expected to remain independent from the campus utilities for the near-term future due to multi-tenant usage and Montgomery College's partial occupancy of the building. If the usage or occupancy changes in the future, the feasibility, cooling demands and cost benefits for connecting the building to the campus chilled water system should be evaluated, as limited capacity is available in an underground vault near the PK building.

An additional consideration when evaluating cooling loads in the future is the impacts of climate change, and its impact on peak cooling loads. It is recommended that current ASHRAE design temperatures be reviewed periodically to evaluate existing buildings cooling loads and future buildings impact to the campus distribution.

All future buildings should include the incoming decoupler piping configuration that has been installed elsewhere on campus to continue the primary and secondary pumping configuration. Meters and sub-meters should be included on all renovations and new construction to allow Montgomery College to monitor energy usage benchmarking of the buildings HVAC systems and individual system usage.

## **MECHANICAL SYSTEMS – HEATING WATER**

### **Scope**

The 2022 UMP provides documentation, analysis and recommendations of the existing and future heating water systems at the Germantown campus based on the Facilities Master Plan 2013–2023. This study documents the existing equipment and capacities of the installed mechanical equipment in the central plants as well as the demand load for heating of each building. The study also provides recommendations to improve performance of the existing systems and distribution piping along with modifications that are required as buildings are constructed or renovated. Drawing M1.11 in Appendix 3 shows a site plan of the existing heating water system. Drawing M1.12 in Appendix 3 shows a site plan of the near-term heating water system. Drawing M1.13 in Appendix 3 shows a site plan of the long-term heating water system. Additionally, part plan schematics are referenced to indicate the central plant piping configurations.

### **Existing Conditions**

The Germantown campus currently has heating water boilers located in three locations on campus, BE, HT and HS buildings. In the BE central plant, three (3) gas-fired Aerco Benchmark condensing water boilers were installed in 2013 during the construction of the building and central plant. These boilers are connected to primary distribution pumps which deliver heating water to an underground high-performance distribution piping system. Currently the only buildings that are connected to the BE heating plant are the BE, SA and CG buildings. The BE condensing boilers currently supply water to the satellite buildings at 180°F and utilize a 20°F temperature differential. The SA building previously was installed with four (4) “multi-pulse” boilers, but have been removed during the current renovation of the south portion of the building. The heating water piping from the BE plant is routed into the SA building and then back underground across the west parking lot to the Child Care Center (CG). A HVAC vault also provides a future branch north routed adjacent to the existing chilled water piping for a future connection to the existing heating water underground piping in the northern portion of campus. This underground Perma-pipe piping was extended to the southeast corner of SA during the BE construction and extended north the northeast corner of SA and is terminated at direct buried valves. At each of the connected buildings, BE, SA and CG a piping bridge is installed to decouple the primary distribution piping from the secondary or building piping loops. Each building includes their own set of building distribution pumps and a BTU meter to monitor water flow rates and building energy usage.

In 2013, the existing “multi-pulse” boilers in High Technology (HT) were replaced with three (3) gas-fired high efficiency Aerco Benchmark condensing boilers. The HT boilers are installed within the central cooling plant, but are currently operated and distributed locally to the HT building. The “multi-pulse” boilers in the Humanities building (HS) were also replaced in 2013 with the same model and capacity Aerco condensing boilers as the HT building. The HS boilers include a primary and secondary pumping system to provide heating water to the building loop of the HS building as well as distribute heating water to the underground campus loop that currently only serves PG. The HS building utilizes heating water to provide heating from domestic water heating. The HS building previously had solar domestic hot water panels on the roof with a storage tank and pump in the mechanical room. At the time of this study the solar heating panels have been removed and the tank has been abandoned in place leaving the system non-operational. The underground heating piping the boilers, located in HS, enters the PG building in two separate locations. One location includes a shell & tube heat exchanger to provide heating for a natatorium and separate domestic hot water piping. The piping between the HS and PG buildings was replaced in 2005 with direct buried CPVC piping. The HS and PG building have their own BTU meter and building distribution pump to circulate water within the building and monitor energy usage of the building. The HT & HS boilers currently supply heating water at 160°F and utilize a 20°F temperature differential for the heating water distribution.



The Paul Peck building (PK) is one of Montgomery College's buildings on the Germantown campus, which was purchased and has been updated in recent years. The building is stand-alone from the rest of campus and is partially occupied by MC and leased by other tenants. During the construction and connection of CG to the BE plant, a vault was installed adjacent to CG & PK which is capable of providing a limited heating water capacity to PK in the future. Two additional standalone buildings located on campus are the Greenhouse and Vehicle Maintenance Shop. The Greenhouse currently utilizes gas heat, and the Vehicle Maintenance Building is served by propane heaters.

The existing building heating loads can be found in Table 3-1 in Appendix 3. The heating loads have been gathered from existing pump sizes, square footage factor estimates and original construction drawings. The smaller structures on campus have not been included on this table. Primary heating water distribution pumps located at the individual boiler plants deliver the 190°F water to the satellite buildings by underground piping. As previously mentioned, at each of the connected buildings bridge piping assembly then decouples the primary loop from the building or secondary loop, where building distribution pumps deliver heating water to the building based on heating demand. As heating demand increases or decreases throughout the day, the building pumps are able to decrease/increase water flows by use of variable frequency drives (VFD) and target an optimal operating setpoint. By calculating a differential pressure at each building due to water usage, the primary pumps ramp up or down by VFD control to meet the campus heating demand. The detail included in Appendix 3 indicates the typical piping installation and valve arrangement for a typical satellite building connection. A table of all the existing plant equipment can be found in Table 3-5.

### Previous Master Plan

Since the previous master plan the Bioscience (BE) building has been constructed which includes a new heating plant and distribution piping for the southern portion of campus. The other update since the 2013 UMP is the replacement of the existing multi-pulse boilers with new condensing boilers in the HT and HS buildings, while the boilers have been removed from the SA during the current renovation. The recommendations from the previous utilities master plan largely remain accurate as future buildings and renovation construction takes place on the northern portion of campus a new heating plant will be required to provide adequate capacity to meet the campus' heating demands.

### Future System Requirements

The future campus heating requirements have been separated into two timelines to approach the near-term and long-term heating demands of the Germantown campus. Refer to Table 3-2 and Table 3-3 for the expected building loads.

The existing campus heating capacity connected load requirements are marginally short when compared to the heating water plant capacities for the campus. Currently, there are no concerns with capacity issues, as the connected load of 16,325 MBH, is short by 3%. The difference in connected load in capacity could be due to the building load estimates and oversized loads due to future upgrades. Due to diversity of an estimated 80% of the heating water system based on occupancy of the campus buildings estimates a peak load of 13,060 MBH, there are currently no concerns with heating water capacity shortages. The future renovations of the SA and HS buildings and construction of the new Student Services (SD) building are expected to increase the campus heating demand by approximately 20% to 20,125 MBH in the near-term future which will require additional heating water source equipment. A new heating water satellite plant would be constructed in the SD building to meet the growing campus heating demands. The new heating water satellite plant would provide approximately 8,000 MBH of additional heating to campus and back feed the campus with new high performance underground piping to replace the existing 3" distribution piping, which would be undersized for future distribution. The extension of new underground heating water piping to the existing campus piping will be

reviewed and evaluated based on the construction budget during the design and construction of the SD building. If this extension is not completed during the initial construction of the building it should be considered during a future campus infrastructure project, to connect the north campus with the southern heating water piping. The new campus connected load would be 20,125 MBH and with the addition of the new satellite heating plant, the campus would have 23,840 MBH of heating capacity. The peak load of the campus would be estimated at 19,070 MBH when considering campus diversity. The near-term firm capacity for campus would also grow to meet the new peak load, considering the loss of one of the BE plant's 2,700 MBH boilers, the firm capacity would be 21,140 MBH which meets the campus' estimated peak future load.

The PK building is expected to remain as a stand-alone building and remain independent from the Germantown central heating systems. A utility vault is located in the adjacent parking lot, this vault could be utilized to serve part of PK's heating water needs if found to be cost effective installation. Only heating for approximately 10,000 GSF is expected to be available for PK's use. There are several potential buildings to be built on or around the Germantown campus associated with the Pinkney Innovation Complex for Science and Technology at Montgomery College (PIC MC), but these buildings will remain independent from the campus utilities due to differences in funding sources. Additionally, in the future an evaluation should be completed to convert the Vehicle Maintenance Shop from propane heating to natural gas heating.

The existing boilers within HT & HS have all been installed within the past seven years and are in good operating condition. When the boilers need replacement, they would be replaced with high efficiency condensing boilers within the new SD central heating plant. The anticipated initial capacity of the SD plant would be 8,000 MBH to match the capacity requirement of the building, but include space for a future expansion. When the HT & HS boilers are replaced the SD plant would be expanded to 16,000 MBH to support the north portion of campus, including HS, HT, PG & SD. The existing BE heating water piping will also be extended and connected to the north portion of campus to provide redundancy across the campus heating water plants.

The existing heating water campus distribution pumps appear to be good operating condition currently, but should be maintained and re-evaluated every few years to determine if they require replacement. When a pump is replaced, it would be installed with a variable frequency drive to control operation and allow for the pump to ramp down during campus part loads.

In the future the addition of a combined heat and power (CHP) plant should be reviewed for feasibility with Montgomery College and potential utility partners. The CHP plant would be constructed in close proximity to the existing underground heating water piping to allow the plant to reject heat into the existing distribution piping for campus wide use. Adding these systems to campus would allow the campus to operate its own microgrid while utilizing the waste heat from the power generation, refer to the electrical section of this report for additional information. While the use of natural gas for heating conflicts with the County's Climate Action Plan, the continued use of this fuel source for heating generation is the most economical option at this time.

## Summary and Recommendations

The Germantown campus heating water systems separated between three different heating plants. The central heating plant located in the BE building, the HS satellite heating plant and the HT local heating plant. The major Montgomery College buildings, BE, CG, HS, SA, HT and PG are supported from these heating water plants. The PK building, which is partially occupied by MC, is supported locally by its own building heating systems. All of the heating water plants consist of three (3) Aerco high efficiency gas-fired condensing boilers. Each heating water plant utilizes primary pumps

to distribute water from the boilers to the secondary or building piping distribution loop. The building piping decouples from the plant primary piping loop and includes a BTU meter for energy monitoring.

The BE plant piping distributes heating water to several buildings on campus including, the SA, CG and BE building. This underground high-performance insulated distribution piping also is routed north towards a future connection with the rest of campus. The HS satellite heating plant provides heating water to the HS and PG building. The underground piping enters the PG building in two locations, where it provides comfort heating, domestic water heating and utilizes a shell and tube heat exchanger to pool water heating. The HT heating plant, which is a part of the HT chilled water central plant, provides heating water and domestic water heating to the HT building only. The 3" piping routed from the BE plant to the north will be extended to the existing SA and HT plants under future projects to allow for redundancy and increased capacity.

In the near-term future the new Student Services Center will be constructed to the west of the PG building. As the campus is currently only able to marginally meet the connected capacities of the campus heating loads, a new satellite heating plant will be required for the SD building. The new heating water satellite plant would include adequate space to expand to add future capacity to support the SD building, in addition to future addition to the PG building and replacement of the boilers in HS & HT. The new satellite plant would initially be capable of providing 8,000 MBH of firm capacity with a standby boiler and pump for redundancy. In the future boilers in the HT and HS buildings will require replacement as they reach the end of their expected useful service life. At which time, the HT & HS boiler plants would be consolidated into the new SD central plant would be expanded to a future capacity of 8,000 MBH. The new boilers would be gas-fired high efficiency condensing boilers similar to those recently installed on other campuses.

The long-term future for the campus will require the replacement of some of the existing underground piping with larger size piping for improved distribution from the future central plant in SD to satellite buildings. All CPVC underground piping would be replaced with jacketed pre-fabricated high performance underground piping for energy savings and longevity. New HVAC vaults should be installed to provide future connections to the campus heating water distribution piping as new buildings are constructed. Capacities should also be re-evaluated at the time of equipment replacement to confirm there have been no changes in heating water demand or any overall changes to the facilities master plan of the campus.

Additionally, it is recommended that campus domestic hot water and pool heating systems be evaluated for possible removal from the central heating water system. If these systems are removed, the central heating water system may see an increase in overall efficiency due to reduced return water temperature at the condensing boilers. To accommodate this, local boilers/water heaters will be needed in each building with a domestic hot water and pool heating requirements.

An additional consideration when evaluating heating loads in the future is the impacts of climate change, and its impact on peak heating loads. It is recommended that current ASHRAE design temperatures be reviewed periodically to evaluate existing buildings heating loads and future buildings impact to the campus distribution.

All future buildings should include the incoming decoupler piping that has been installed in elsewhere on campus to continue the primary and secondary pumping configuration. Meters and sub-meters should be included on all renovations and new construction to allow Montgomery College to monitor energy usage benchmarking of the buildings HVAC systems and individual system usage. As controls are provided or replaced that should be integrated with all heating plants to ensure optimal controls and communication. A new combined heat and power plant should also be

considered on campus to allow for the creation of a new microgrid on campus with heat rejection to the campus heating water distribution.

## **ELECTRICAL SYSTEMS – POWER**

### **Scope**

The 2022 UMP provides documentation, analysis, and recommendations of the existing and future electrical power systems that serve the Germantown campus based on the Facilities Master Plan 2013-2023. This master plan documents the existing utility and campus owned electrical service entrance equipment, associated demand loads, and capacities. Estimated demand loads for future buildings and building modifications are also included. The master plan provides basic recommendations for distribution system modifications required to meet the future estimated demand loads. Drawing E1.01 in Appendix 4 shows a site plan of the existing campus power distribution system. Drawing E1.02 in Appendix 4 shows a site plan of the proposed near-term campus power distribution system. Additionally, campus electrical power distribution single-line diagrams are provided in Appendix 4 to show the general configuration of the electrical system.

### **Existing Conditions**

All existing buildings at the Germantown campus receive electrical power from the local utility company, the Potomac Electric Power Company (PEPCO). The service is an underground loop 13.2kV feeder, originating at a PEPCO overhead line feeder 14880, which enters the campus near the intersection of MD Route 118 and Goldenrod Lane. A second PEPCO 13.2kV feeder, 14889, interconnects with the campus along MD Route 118. The 13.2kV feeder once it leaves the pole at Route 118/Observation Drive at the autoshop is underground and stays underground as it loops around campus to the pad mounted transformers. There have been several instances where these older feeders have failed or the overheads on Route 118 have been damaged and caused campus wide outages. The autoshop has a separate residential style service with a pole mounted transformer on Route 118. This transformer also serves the ball field and may currently or already have completed an upgrade.

PEPCO owns and maintains the medium voltage (13.2kV) feeders and exterior pad mounted transformers that supply power to the individual service locations. The Germantown campus buildings are individually metered by PEPCO. Montgomery College owns, maintains and operates the electrical distribution systems downstream of the PEPCO meters. Each of the facilities has a separate PEPCO meter, electrical service, and associated service entrance disconnect with the exception of the Physical Education Building (PG) which is served from the Humanities and Social Sciences Building (HS). The Paul Peck Academic and Innovation Building is standalone with a PEPCO utility feed separate from the rest of the campus. Table 1 in Appendix 4 lists the individual service locations.

All of the college service distribution equipment is three phase except for the Child Care Center (CG) which has a single phase service. The service entrance equipment serving the various buildings are by a variety of equipment manufacturers including General Electric, Eaton, Square D, and Siemens. The condition of the service entrance equipment generally ranged from fair to good condition.

The electrical peak demand load for each of the existing service locations is shown in Table 4-1 in Appendix 4. The estimated total campus peak demand load is 3.6MVA and is calculated by summing all of the individual service locations. It is important to note that the estimated total campus peak demand load will be less than the actual total campus peak demand load due to the fact that not all individual peak demand loads at each individual service occur at exactly the same time.

Existing photovoltaic systems are installed on buildings HS and SA totaling 80kW of capacity. HS and SA's thin film amorphous PV systems have been removed. HS due to a roofing project and SA due to the recent renovation. SA's roof does currently have structure for future PV. BE has a 35kW PV Array and 5 x 1kW demonstration wind turbines.

The existing Student Affairs and Science Center (SA) building is currently being renovated to include a new addition with an expected completion in Summer 2019. The existing PEPCO pad mounted transformer serving the building has been removed. A new PEPCO pad mounted transformer has been provided in a new location. The existing to remain underground ductbanks have been extended to the new transformer.

Backup power is provided to various buildings through the use of generators. Buildings with backup generators have been identified in Table 4-1 in Appendix 4. Generator capacity (KW) is also indicated.

### **Previous Master Plan**

Per the previous utilities master plan, the existing PEPCO feeders were shown as having adequate capacity to accommodate future loads associated with the College's planned growth. See below for a description of ongoing efforts to verify if PEPCO's feeders and associated infrastructure are adequate to support the College's planned growth.

### **Future System Requirements**

As previously mentioned, the existing PEPCO distribution system is believed to be adequate to serve the future campus buildings. PEPCO will remain the owner and operator of the 13.2kV voltage electrical distribution system, so any desired modifications to this system will need to be coordinated with PEPCO. The existing 13.2kV PEPCO electrical distribution system shall be extended to all new buildings throughout the campus.

The near-term and long-term future campus projects include several demolition and new construction projects throughout the campus. These projects and the anticipated year of completion are listed in Table 4-2.

Projected load estimates for the new buildings shall be provided to PEPCO in order to determine if the existing PEPCO owned electrical distribution infrastructure has sufficient capacity for the new loads. A PEPCO service application will need to be submitted to begin this process. The College design is to be reviewed and approved by PEPCO as part of the service application process. The infrastructure is installed by College contractors after which PEPCO installs cabling in the infrastructure from the poles to the transformer pads, set the transformer and feeders from the transformer pad to the building service entrance. PEPCO is paid a fee for their work.

Some buildings/locations are not currently metered separately from their source, however submetering should be provided to allow MC to better track usage and maintenance. The ball field, fed from the autoshop, is not metered separately so it will require a sub-meter. The Greenhouse (GN) is fed from the High Technology and Science Building (HT) and will require a sub-meter.

Please note that PEPCO has not provided detailed information to date regarding the construction of future buildings as it relates to the impact to existing PEPCO primary feeders and associated infrastructure. Load information on campus load growth has been provided to PEPCO and through the efforts of key College personnel, requests for information from PEPCO are ongoing.

Designers for all future buildings at Montgomery College Germantown Campus should be aware that Schneider Electric has prepared a Power Purchase Agreement (PPA) preliminary concept. Schneider Electric did this through the completion of a MicroGrid Qualifications and Analysis exercise in October 2019. The concept presented to the College was based on Schneider Electric purchasing and maintaining all of the PEPCO owned primary distribution and pad mounted transformers currently supporting the Germantown Campus, then selling power back to the College for a term of 20 years. The discussions were preliminary in nature, but are still being considered by the College.

Montgomery County requires that all projects that receive county funding be provided with PV at a rate of 1kW/1,000 SF renovated or newly constructed for projects larger than 10,000 SF. Identification of possible locations for future PV is included in this report. See Table 4-3 and Site Plan E1.04. Proposed PV locations are displayed for rooftop, parking lot, and ground mounted PV systems. Locations have been determined by evaluating the available physical space within the Campus to accommodate the panel arrays. Montgomery College will need to evaluate these potential locations for additional criteria such as feasibility, cost, and environmental impact. This UMP is the first to begin to identify possible areas (roof, ground & parking canopy) areas where PV may be located and the potential cost avoidance. This is important given increased emphasis on on-site renewable power generation to meet net-zero goals and the need for, on a master plan basis, the institution embrace the concept since PV will require a 20+ year commitment to Power Purchase Agreements (PPA). For example, placement of a building on the footprint of a PPA solar field, mid-contract, will require breaking the PPA contract and making the PPA contractor whole. Solar will also have to be sub-metered and monitored by the EMS.

## Future Utility Upgrades

The Germantown Campus was originally constructed as an all-electric campus during the natural gas moratorium in the late 70s to mid-80s, with the three buildings, SA, HS & PG. PG was connected to HS for electricity, domestic water and hot water. Two double wide trailers provided day care and were electrically connected to HS. A high pressure natural gas line was extended from Middlebrook Road in the early 90s and gas was supplied to pulse combustion boilers in HS & SA replacing the electric hot water boilers. HT construction in the early-mid 90s eliminated the day care trailers and provided a new central chilled water plant for the campus. Expansion of the HT chilled water plant, addition of a plant transformer and service and extension of the chilled water distribution piping to HS, PG & SA further reduced the load on the PEPCO transformers in HS & SA. When BE was being designed, PEPCO adding the connected transformer capacity questioned adding BE's capacity to the existing 4000kVA feeder. The College's actual demand loads demonstrated to PEPCO that the actual load on the feeder was low enough to accept the new BE loads. A similar discussion demonstrated to PEPCO that the capacity of the renovated SA building would not exceed the feeder capacity. However, the proposed Student Service Building (SD) will exceed the capacity and will require feeder upgrades. The single feeder also leaves the campus vulnerable to complete campus outages. Two solutions have been discussed with PEPCO to provide power to the new SD building and increase the available capacity on the campus.

The first solution, the North Loop, consists of providing a new PEPCO service from an existing pole along Route 118 to a new pad mounted transformer to serve the SD building. This new service would provide 5,000kVA of available capacity, however 2,500kVA of the available capacity is anticipated to be used by the SD building. This leaves 2,500kVA of future capacity for the campus. This solution also offers no redundancy of power for any of the new or existing buildings on the campus. This report previously mentioned instances where the older utility feeders have failed or the overheads on Route 118 have been damaged and caused campus wide outages. With this North Loop solution, these outages would continue to occur and in those instances the campus would be without power until PEPCO resolves the issue. A cost estimation from PEPCO indicated that the North Loop would cost approximately \$200,000 to install cabling from the existing PEPCO pole on Route 118 to the new transformer at the Student Service Building (SD).

This cost does not include the 1000' of 4-way concrete encased conduits or 2 manholes that would need to be provided by the College. For additional information refer to New North Loop Drawing E1.05.

The second solution, the South Loop, consists of providing a new PEPCO service from the existing utility vault at the Holy Cross Germantown Hospital. This loop would continue to the south side of the campus to a new switch and fuse boxes. One (1) fuse will be provided to serve the existing campus buildings, one (1) fuse will be provided for the new SD building, and two (2) spaces will be provided with 10,000kVA capacity. New conduits will extend from the fuse boxes to the existing campus distribution system and also to the new SD building transformer. This solution would allow for the entire campus to have a second source of power in case an outage occurs. A cost estimation from PEPCO indicated that the South Loop would cost approximately \$1,805,000 which includes the switch, fuse boxes for 4 fuses (1 fuse for new SD building, 1 fuse for existing campus, 2 spaces for future with 10,000kVA capacity), 5 manholes, 1 splice box, 2000' of 8-way 5" concrete encased conduits, 1000' of 4-way 5" concrete encased conduits, and installation of cabling. A ROM cost was developed for the College's work associated with the South Loop. The College's cost for this work is anticipated to be \$726,000 and includes 2,800' of 2x4" concrete encased conduits, 700' of 4x4" concrete encased conduits, 8 splice boxes, and miscellaneous patching and pavement repair. For additional information refer to New South Loop Drawing E1.06.

## Summary and Recommendations

The existing 13.2kV electrical distribution system owned by PEPCO will need to be extended to the new buildings. Coordination of all electrical distribution system upgrades shall be coordinated with PEPCO.

It is recommended that the existing campus metering be expanded to include major uses of electrical power. All buildings will need to have College owned electrical sub-meters and all new buildings are to comply with IgCC and IECC building distribution requirements to be able to track the specific loads such as lighting, HVAC, etc. These meters should also be implemented in a manner that complies with MC's new Building Energy Performance Standards. This expanded metering will help facilities staff identify and diagnose maintenance issues as they arise on these systems. It will also help MC be prepared when Montgomery County enforces its new benchmarking law.

Efforts to pursue PEPCO (in association with key College personnel) for definitive information related to the impact of new building load growth must be continued. The recommendations section cannot be completed until the required coordination and results have been obtained from PEPCO.

Efforts to maintain an understanding of the Schneider Electric PPA concept and its status should be continued.

Identification of possible locations for future PV is noted on Table 4-3 and Site Plan E1.04. These possible locations are considered for the near-term future. Montgomery College will need to evaluate these potential locations for additional criteria such as feasibility, cost, and environmental impact.



# bkm

---

Appendix 1  
General Information

---

**TABLE 1-1 - Building Abbreviations List**

Official Abbreviation	Building Number	Building Name	Gross Square Feet (GSF)**	Net Assignable Square Feet (NASF)**	Comments
<b>Germantown Campus</b>					
BE	106	Bioscience Education Center	139,985	80,658	
BS	112	Baseball (all structures)	210	170	
CG	107	Child Care Center	5,535	3,565	
GN	109	Greenhouse	4,562	4,390	
GS	111	Grounds and Auto Shops and Storgae	7,201	6,977	
HS	102	Humanities and Social Sciencenes Building	75,700	52,234	
HT	104	High Technology and Science Center	75,542	42,673	
PG	103	Physical Education Building	36,770	29,338	
PK	105	Paul Peck Adademic and Innovation Building	68,826	52,534	
SA	101	Dr. DeRionne P. Pollard Student Affairs and Science Building	99,648	55,991	<i>Formally Science and Applied Studies Building</i>
SD*	110	Student Services Center	153,660	87,586	<i>2027 Expected Opening</i>
TBD*	-	Science/Math/Science Center	34,200	20,520	<i>2054 Expected Opening</i>
TBD*	-	Arts and Commuication Building	72,000	20,520	<i>2060 Expected Opening</i>

\*Building Proposed per 2016 Facilities Masterplan

\*\*From MC Resource Conservation Plan FY 2023 and from the Facilities Master Plan 2013 - 2023

**TABLE 1-2: List of Abbreviations**

BTU .....	BRITISH THERMAL UNIT
W .....	COLD WATER
CW .....	CHILLED WATER
GSF .....	GROSS SQUARE FEET
GPM .....	GALLONS PER MINUTE
FMP .....	FACILITIES MASTERPLAN
HP .....	HORSEPOWER
HR .....	HOUR
HW .....	HEATING WATER
KVA .....	KILOVOLT-AMPERES
KW .....	KILOWATTS
G .....	NATURAL GAS
SF .....	SQUARE FOOT
S .....	SANITARY SEWER
UMP .....	UTILITY MASTERPLAN
VFD .....	VARIABLE FREQUENCY DRIVE



PROJECT NAME:  
**Montgomery College**



**GERMANTOWN**  
**CAMPUS**  
**UTILITY MASTER**  
**PLAN**

SEAL:

ISSUED FOR:

DATE:	DESCRIPTION:
JUNE 2022	FINAL

PROJECT NO: BKM # 19021.01  
 SCALE: AS NOTED  
 DRAWN BY: BKM  
 CHECKED BY: BKM  
 DATE: JUNE 2022

SHEET TITLE:  
**COMPOSITE SITE PLAN**  
**EXISTING CONDITIONS**

DRAWING NO:  
**C1.01**  
 BKM# 19021.01

- LEGEND:**
- CHILLED WATER
  - HEATING WATER
  - DOMESTIC COLD WATER
  - SANITARY
  - STORM WATER
  - NATURAL GAS
  - CONDENSER WATER SUPPLY/RETURN
  - GLYCOL WATER SUPPLY/RETURN
  - ELECTRIC

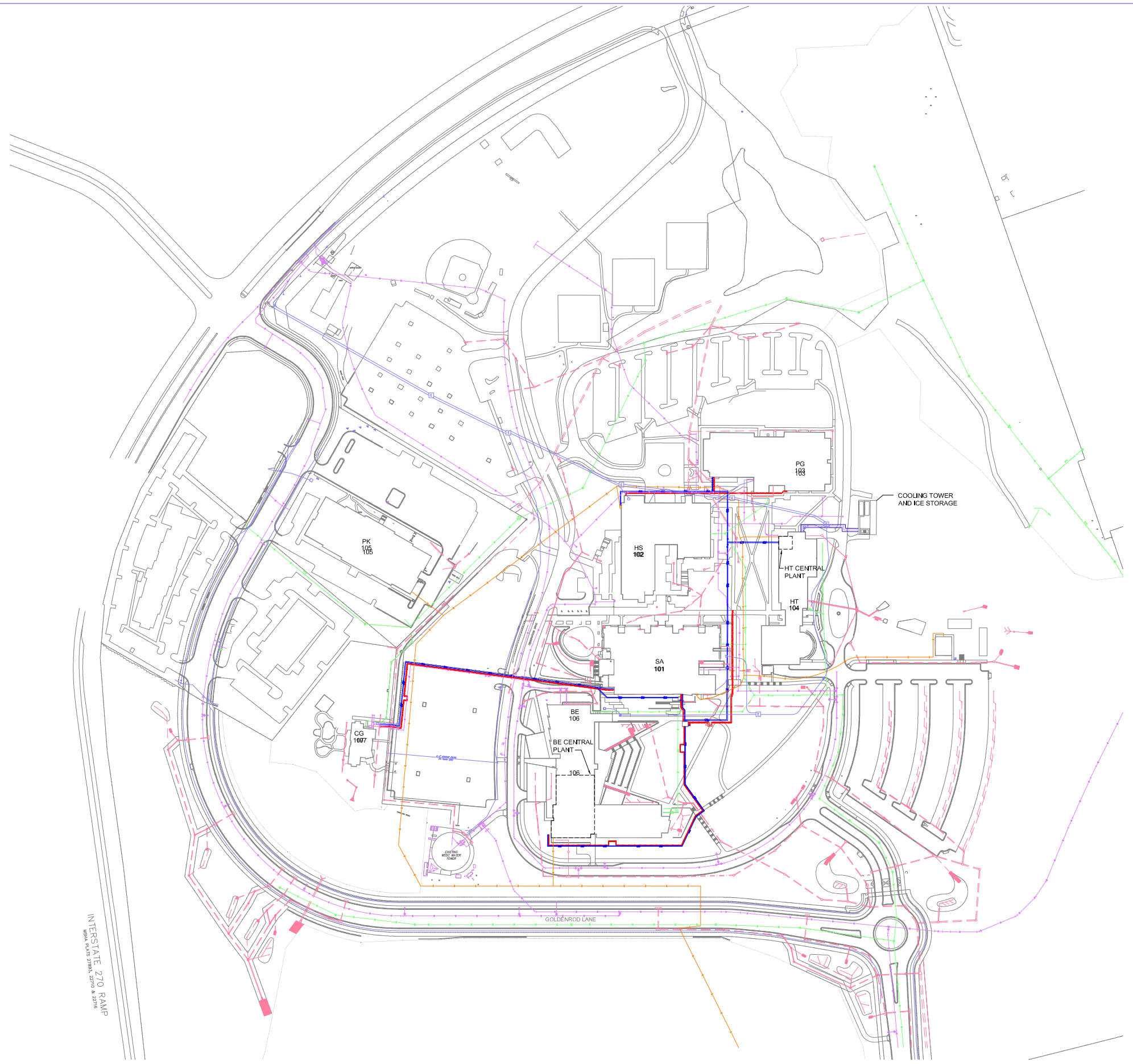

**1 COMPOSITE SITE PLAN - EXISTING CONDITIONS**  
 SCALE: 1" = 100'-0"

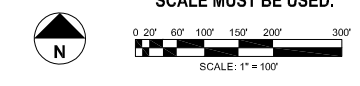

Plotted By: Tyler Koell | 6/17/2022 12:39 PM  
 ARL-G:\19021.01\Drawings\Acad\MCC\1 - Combined SW Plan Color

PROJECT NAME:  
**Montgomery College**



Central Administration  
 Office of Facilities  
 9221 Corporate Boulevard  
 Rockville, MD 20850  
 Telephone: 240-567-7363

**GERMANTOWN  
 CAMPUS  
 UTILITY MASTER  
 PLAN**

SEAL:

ISSUED FOR:

DATE:	DESCRIPTION:
JUNE 2022	FINAL

PROJECT NO: BKM # 19021.01

SCALE: AS NOTED

DRAWN BY: BKM

CHECKED BY: BKM

DATE: JUNE 2022

SHEET TITLE:

**COMPOSITE SITE PLAN  
 NEAR-TERM FUTURE  
 (2022-2034)**

DRAWING NO:  
**C1.02**  
 BKM# 19021.01

- LEGEND:**
- CHILLED WATER
  - HEATING WATER
  - DOMESTIC COLD WATER
  - SANITARY
  - STORM WATER
  - NATURAL GAS
  - CONDENSER WATER SUPPLY/RETURN
  - GLYCOL WATER SUPPLY/RETURN
  - ELECTRIC

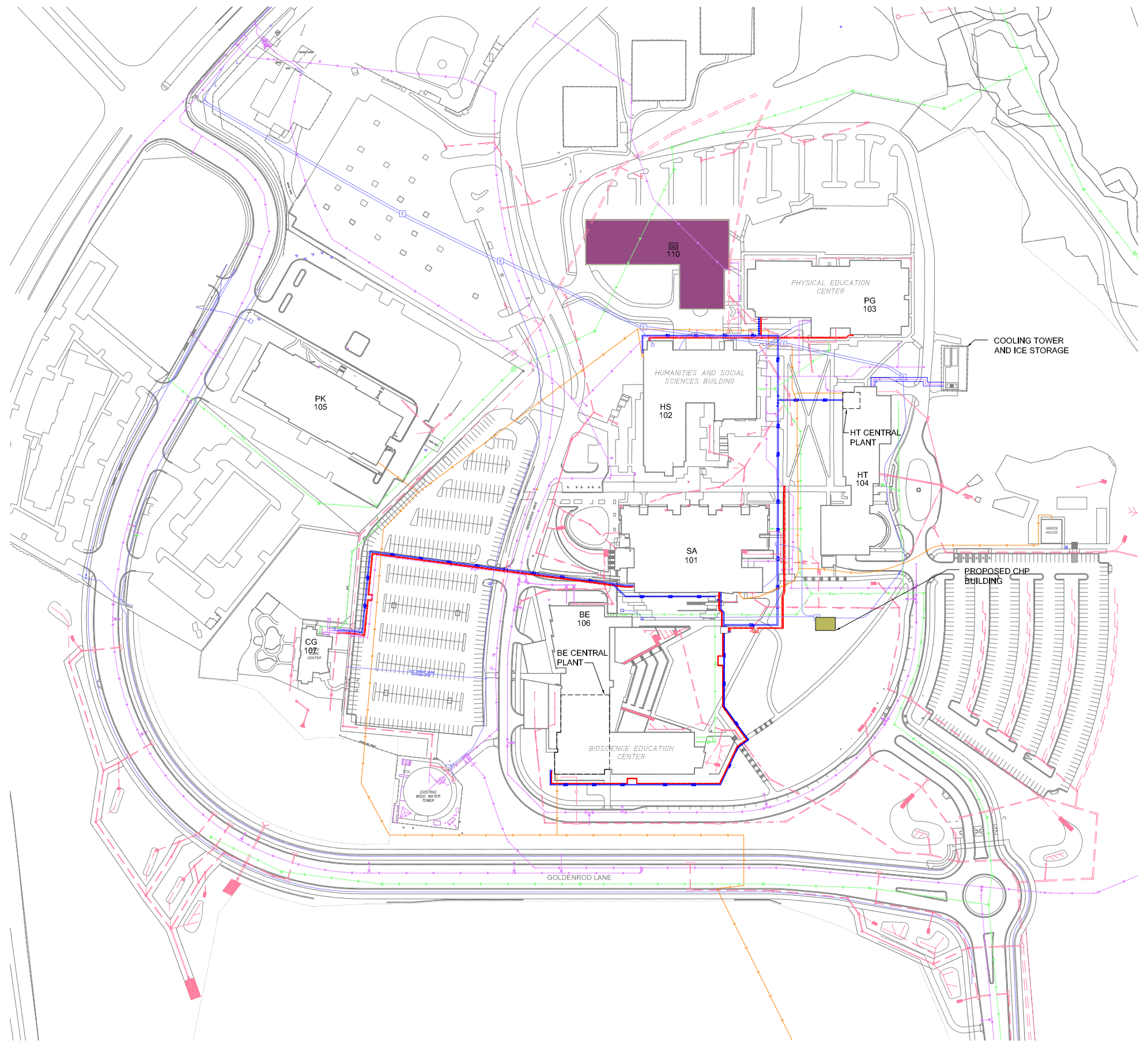

**1 COMPOSITE SITE PLAN - NEAR-TERM FUTURE (2022-2034)**  
 SCALE: 1" = 80'-0"

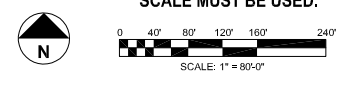

Plotted By: Tyler Koell | 6/17/2022 1:53 PM  
 ARX: C:\19021.01\Drawings\Acad\MCC 02 Composite Site Plan Color.rvt

SEAL:

ISSUED FOR:

DATE:	DESCRIPTION:
JUNE 2022	FINAL

PROJECT NO: BKM # 19021.01  
 SCALE: AS NOTED  
 DRAWN BY: BKM  
 CHECKED BY: BKM  
 DATE: JUNE 2022

SHEET TITLE:  
**COMPOSITE SITE PLAN**  
**LONG TERM FUTURE**  
**(2035-BEYOND)**

DRAWING NO:  
**C1.03**  
 BKM# 19021.01

- LEGEND:**
- CHILLED WATER
  - HEATING WATER
  - DOMESTIC COLD WATER
  - SANITARY
  - STORM WATER
  - NATURAL GAS
  - CONDENSER WATER SUPPLY/RETURN
  - GLYCOL WATER SUPPLY/RETURN
  - ELECTRIC

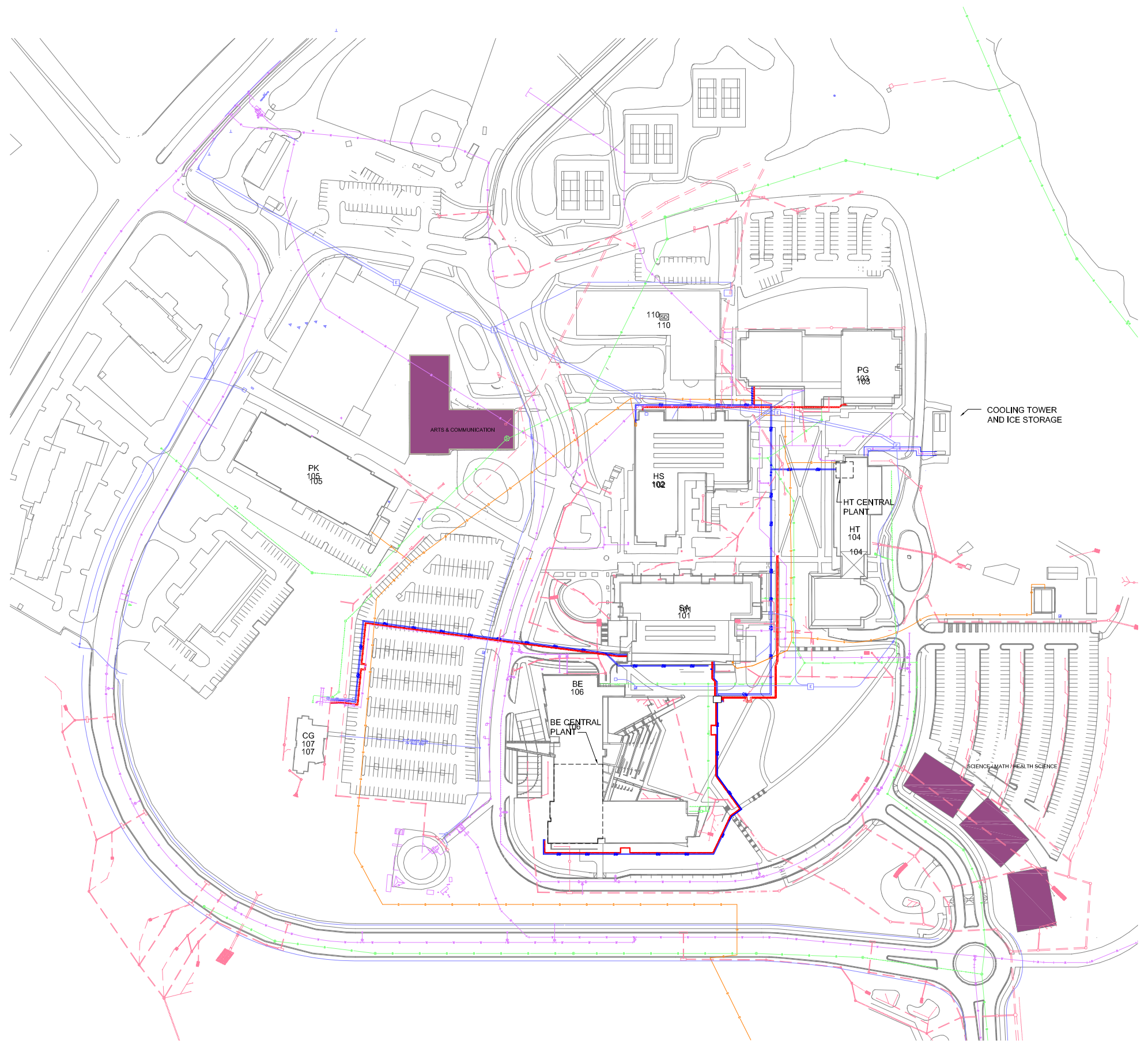

COOLING TOWER AND ICE STORAGE

**1 COMPOSITE SITE PLAN - LONG-TERM FUTURE (2035-BEYOND)**  
 SCALE: 1" = 80'-0"

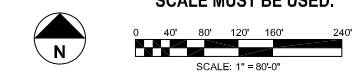

Plotted By: Tyler Koell | 6/17/2022 12:41 PM  
 ARK: C:\19021\01\Drawings\Acad\MCC\03\Composite Site Plan Color.rvt

# bkm

---

Appendix 2  
Plumbing Systems

---



PROJECT NAME:  
**Montgomery College**



**GERMANTOWN**  
**CAMPUS**  
**UTILITY MASTER**  
**PLAN**

SEAL:

ISSUED FOR:

DATE:	DESCRIPTION:
JUNE 2022	FINAL

PROJECT NO: BKM # 19021.01

SCALE: AS NOTED

DRAWN BY: BKM

CHECKED BY: BKM

DATE: JUNE 2022

SHEET TITLE:  
**SITE PLAN**  
**WATER SYSTEM**  
**EXISTING CONDITIONS**

DRAWING NO:  
**P1.01**  
 BKM# 19021.01



**1 SITE PLAN - WATER SYSTEM - EXISTING CONDITIONS**  
 SCALE: 1" = 80'-0"

IF THIS DRAWING IS A REDUCTION, GRAPHIC SCALE MUST BE USED.

SCALE: 1" = 80'-0"

Plotted By: Tyler Koell | 6/17/2022 12:30 PM  
 ARL: G:\19021.01\Drawings\Acad\MP\01\_Domestic Cold Water Existing

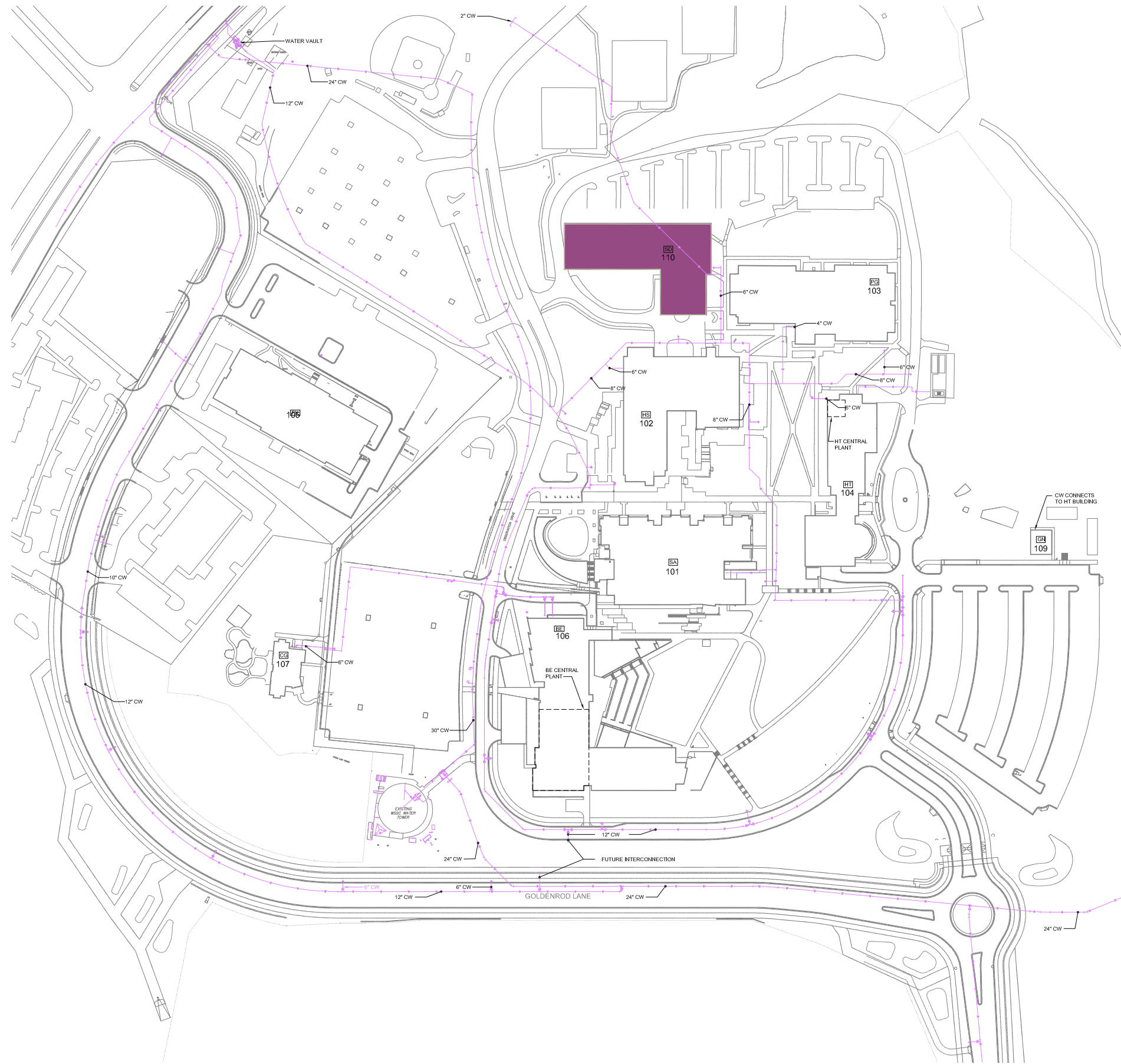

ARL: C:\19021\01\Drawings\Acad\MIP\02\_Domestic Cold Water Near Term Future

Plotted By: Tyler Koell 6/17/2022 1:53 PM

**1 SITE PLAN - WATER SYSTEM - NEAR-TERM FUTURE (2022-2034)**

SCALE: 1" = 80'-0"

**IF THIS DRAWING IS A REDUCTION, GRAPHIC SCALE MUST BE USED.**

SCALE: 1" = 80'-0"



**bkm**  
Burdette, Koehler, Murphy & Associates, Inc.  
Mechanical/Electrical Engineers  
6201 Bell Lane, Suite 400 | Baltimore, Maryland 21209  
P: 410.323.9900 | www.bkma.com

PROJECT NAME:  
**Montgomery College**



**GERMANTOWN CAMPUS UTILITY MASTER PLAN**

SEAL:

ISSUED FOR:

DATE:	DESCRIPTION:
JUNE 2022	FINAL

PROJECT NO: BKM # 19021.01  
SCALE: AS NOTED  
DRAWN BY: BKM  
CHECKED BY: BKM  
DATE: JUNE 2022

SHEET TITLE:  
**SITE PLAN - WATER SYSTEM NEAR-TERM FUTURE (2022-2034)**

DRAWING NO:  
**P1.02**

BKMF 19021.01

SEAL:

ISSUED FOR:

DATE:	DESCRIPTION:
JUNE 2022	FINAL

PROJECT NO: BKM # 19021.01

SCALE: AS NOTED

DRAWN BY: BKM

CHECKED BY: BKM

DATE: JUNE 2022

SHEET TITLE:  
**SITE PLAN - WATER SYSTEM**  
**LONG-TERM FUTURE**  
**(2035-BEYOND)**

DRAWING NO:  
**P1.03**  
 BKM# 19021.01

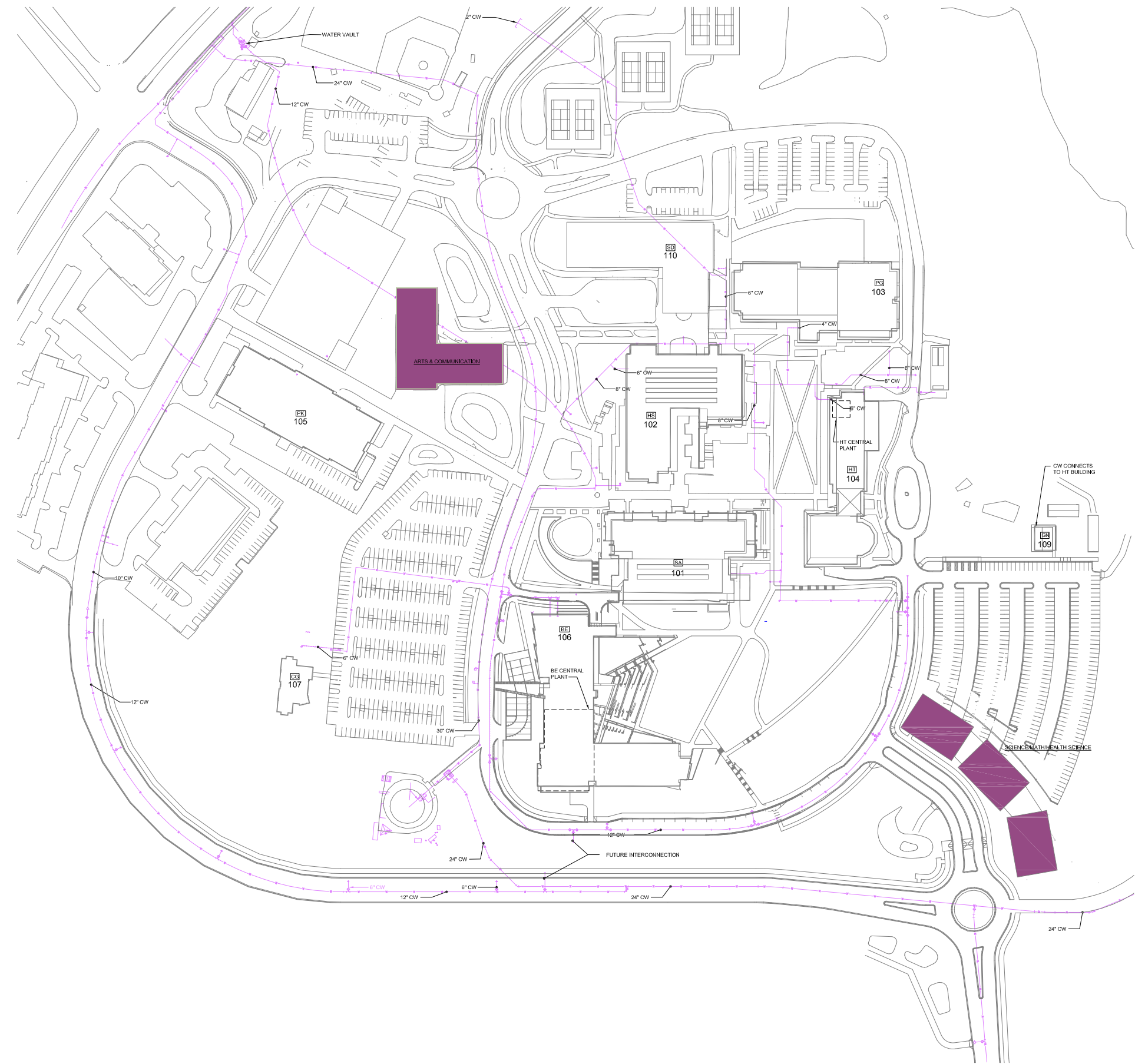

**1 SITE PLAN - WATER SYSTEM - LONG-TERM FUTURE (2035-BEYOND)**  
 SCALE: 1" = 80'-0"

IF THIS DRAWING IS A REDUCTION, GRAPHIC SCALE MUST BE USED.

0 40' 80' 120' 160' 240'

SCALE: 1" = 80'-0"

Plotted By: Tyler Koell | 6/17/2022 12:31 PM  
 ARL: G:\19021.01\Drawings\Acad\MP\03\_Domestic\_Cold\_Water\_Long\_Term\_Future

PROJECT NAME:

**Montgomery College**



Central Administration  
 Office of Facilities  
 9221 Corporate Boulevard  
 Rockville, MD 20850  
 Telephone: 240-567-7363

**GERMANTOWN  
 CAMPUS  
 UTILITY MASTER  
 PLAN**

SEAL:

ISSUED FOR:

DATE:	DESCRIPTION:
JUNE 2022	FINAL

PROJECT NO: BKM # 19021.01

SCALE: AS NOTED

DRAWN BY: BKM

CHECKED BY: BKM

DATE: JUNE 2022

SHEET TITLE:

**SITE PLAN  
 SANITARY SYSTEM  
 EXISTING CONDITIONS**

DRAWING NO:

**P1.11**

BKMF 19021.01



**1 SITE PLAN - SANITARY SYSTEM - EXISTING CONDITIONS**  
 SCALE: 1" = 80'-0"

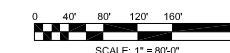

ARL: G:\19021.01\Drawings\Acad\MP1.11\_Sanitary\_Piping\_Existing

Plotted By: Tyler Koell | 6/17/2022 12:32 PM

PROJECT NAME:  
**Montgomery College**



**GERMANTOWN**  
**CAMPUS**  
**UTILITY MASTER**  
**PLAN**

SEAL:

ISSUED FOR:

DATE:	DESCRIPTION:
JUNE 2022	FINAL

PROJECT NO: BKM # 19021.01

SCALE: AS NOTED

DRAWN BY: BKM

CHECKED BY: BKM

DATE: JUNE 2022

SHEET TITLE:  
**SITE PLAN - SANITARY**  
**SYSTEM - NEAR-TERM**  
**FUTURE (2022-2034)**

DRAWING NO:  
**P1.12**  
 BKM# 19021.01

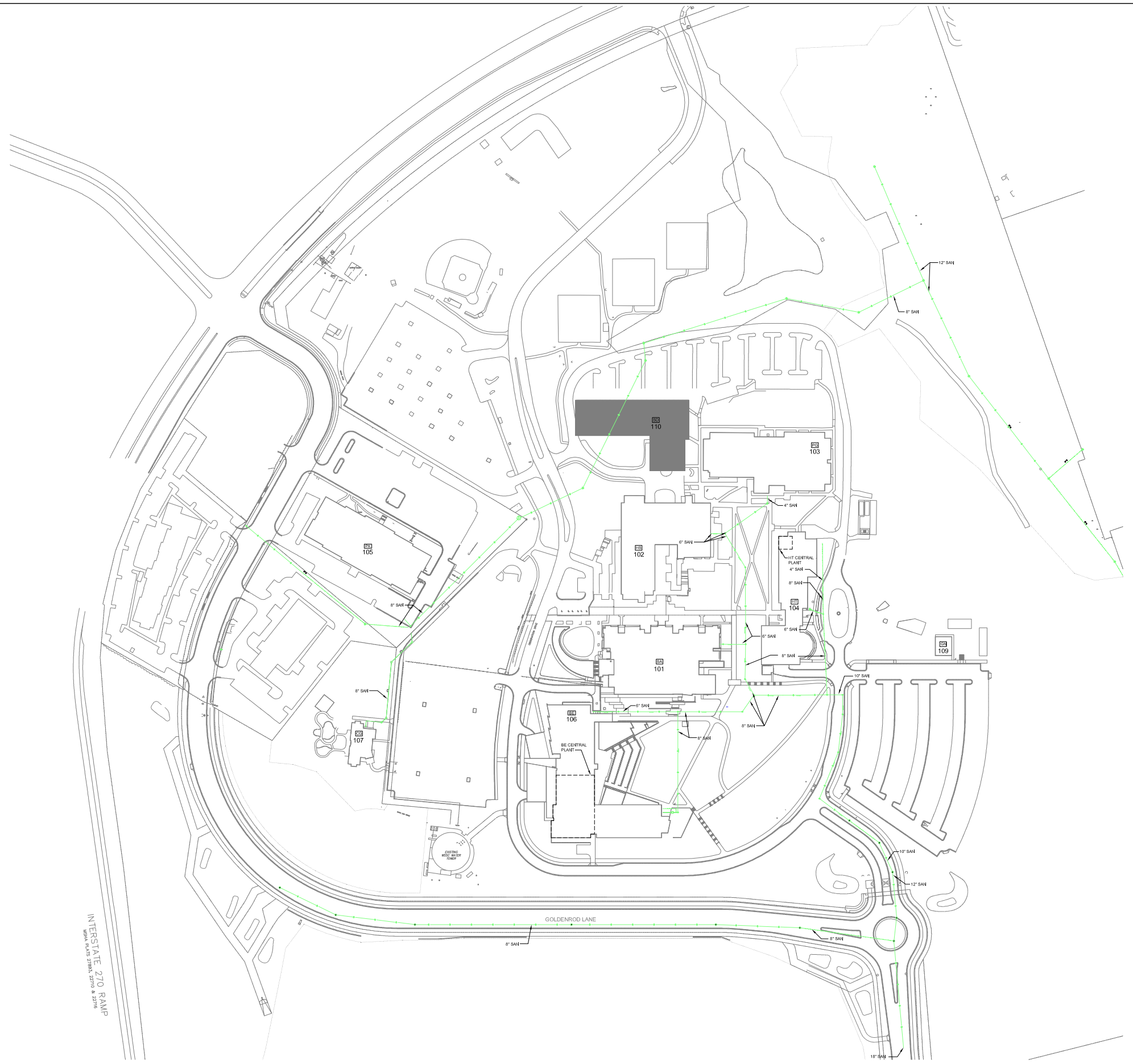

**1 SITE PLAN - SANITARY SYSTEM - NEAR-TERM FUTURE (2022-2034)**  
 SCALE: 1" = 100'-0"

IF THIS DRAWING IS A  
 REDUCTION, GRAPHIC  
 SCALE MUST BE USED.

0 20' 60' 100' 150' 200' 300'  
 SCALE: 1" = 100'

PROJECT NAME:  
**Montgomery College**



**GERMANTOWN**  
**CAMPUS**  
**UTILITY MASTER**  
**PLAN**

SEAL:

ISSUED FOR:

DATE:	DESCRIPTION:
JUNE 2022	FINAL

PROJECT NO: BKM # 19021.01

SCALE: AS NOTED

DRAWN BY: BKM

CHECKED BY: BKM

DATE: JUNE 2022

SHEET TITLE:  
**SITE PLAN - SANITARY**  
**SYSTEM LONG-TERM FUTURE**  
**(2035-BEYOND)**

DRAWING NO:  
**P1.13**  
 BKM# 19021.01

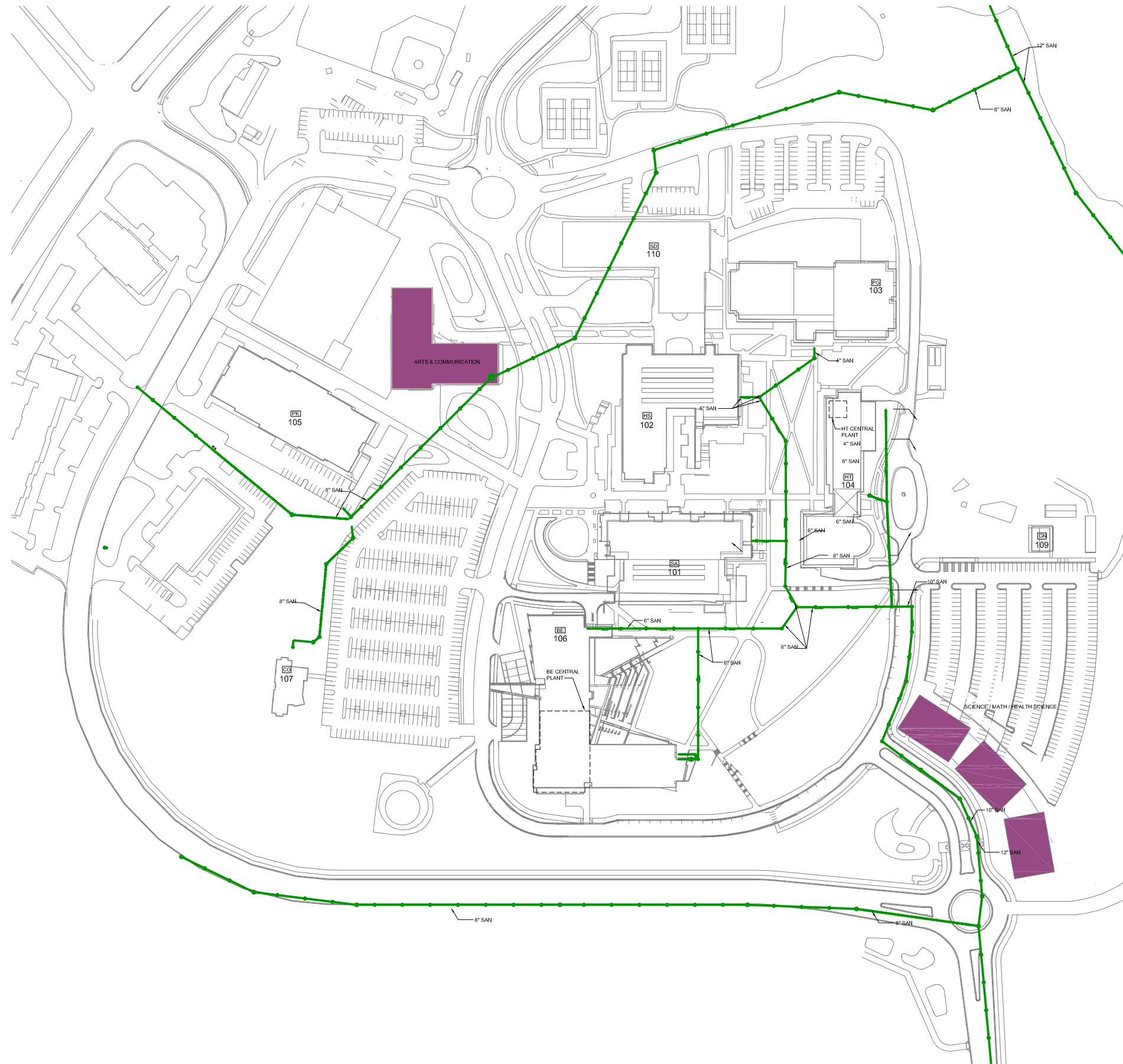

**1 SITE PLAN - SANITARY SYSTEM - LONG-TERM FUTURE (2035-BEYOND)**  
 SCALE: 1" = 100'-0"

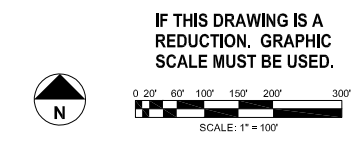

Plotted By: Tyler Koell | 6/9/2022 11:38 AM  
 ARL: C:\19021.01\Drawings\Acad\MFP 13 Sanitary Piping Long Term Future

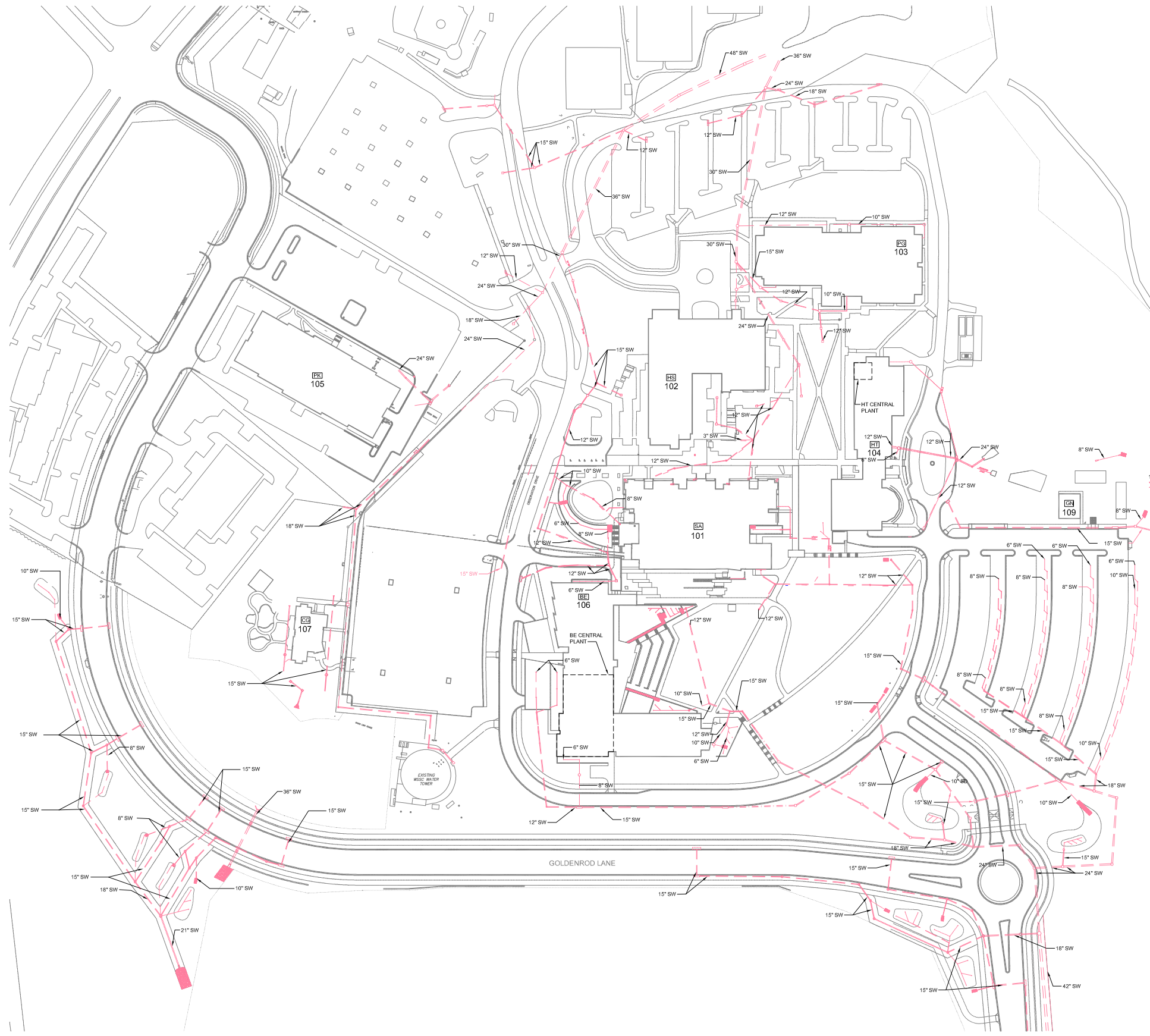

ARL: C:\19021\01\Drawings\Acad\MP\21 Stormwater Piping Editing  
 Plotted By: Tyler Koell | 6/9/2022 11:39 AM

**1 SITE PLAN - STORM SYSTEM - EXISTING CONDITIONS**  
 SCALE: 1" = 80'-0"



IF THIS DRAWING IS A  
 REDUCTION, GRAPHIC  
 SCALE MUST BE USED.  
 0 40' 80' 120' 160' 240'  
 SCALE: 1" = 80'-0"

**bkm**  
 Burdette, Koehler, Murphy & Associates, Inc.  
 Mechanical / Electrical Engineers  
 6201 Bell Hill Lane, Suite 400 | Baltimore, Maryland 21209  
 P: 410.323.0600 | www.bkma.com

PROJECT NAME:  
**Montgomery College**



**GERMANTOWN  
 CAMPUS  
 UTILITY MASTER  
 PLAN**

SEAL:

ISSUED FOR:

DATE:	DESCRIPTION:
JUNE 2022	FINAL

PROJECT NO: BKM # 19021.01

SCALE: AS NOTED

DRAWN BY: BKM

CHECKED BY: BKM

DATE: JUNE 2022

SHEET TITLE:  
**SITE PLAN  
 STORM SYSTEM  
 EXISTING CONDITIONS**

DRAWING NO:  
**P1.21**  
 BKM# 19021.01

SEAL:

ISSUED FOR:

DATE:	DESCRIPTION:
JUNE 2022	FINAL

PROJECT NO: BKM # 19021.01

SCALE: AS NOTED

DRAWN BY: BKM

CHECKED BY: BKM

DATE: JUNE 2022

SHEET TITLE:  
**SITE PLAN - STORM SYSTEM**  
**NEAR-TERM FUTURE**  
**(2022-2034)**

DRAWING NO:

**P1.22**

BKMF 19021.01

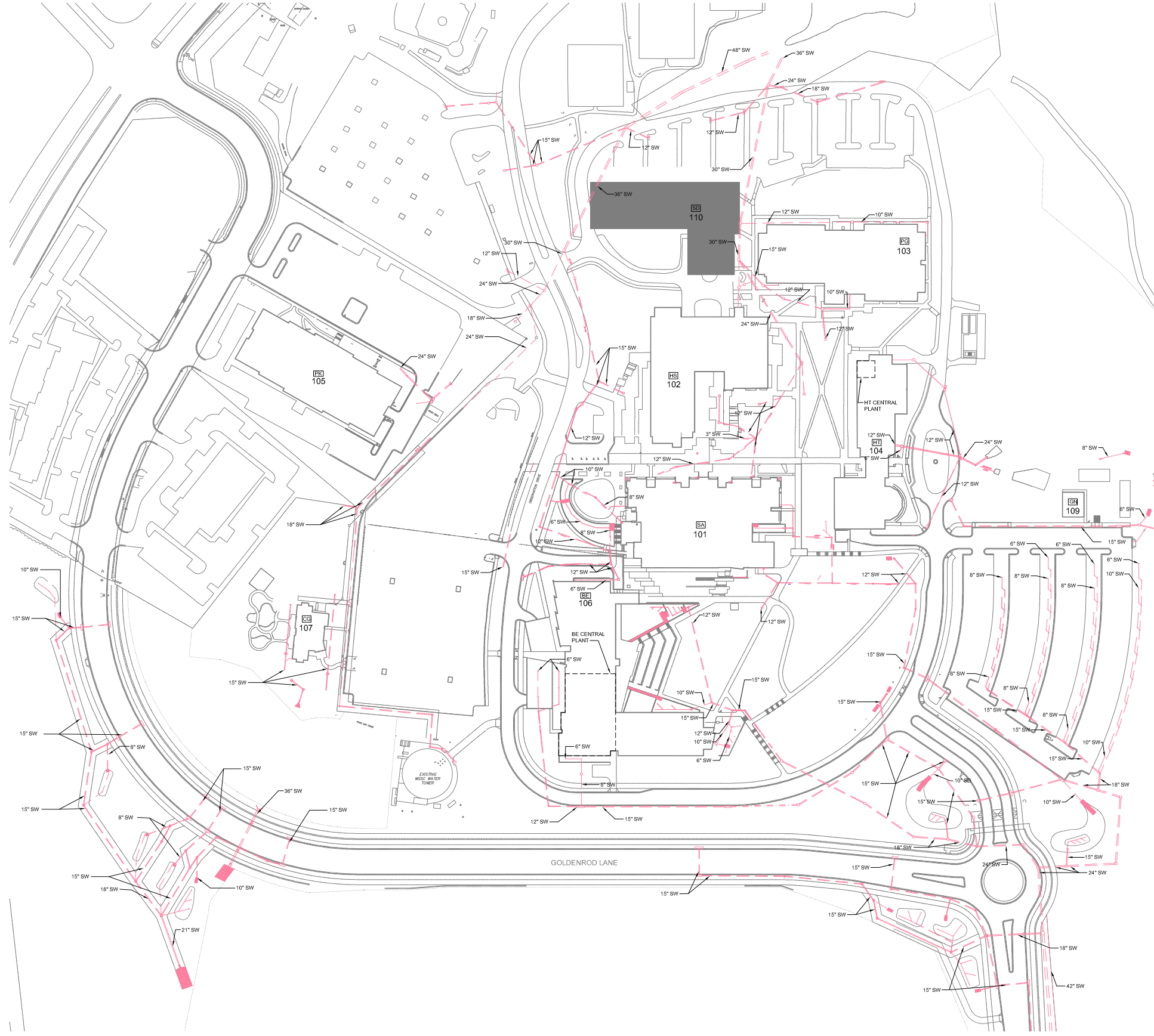

**1 SITE PLAN - STORM SYSTEM - NEAR-TERM FUTURE (2022-2034)**

SCALE: 1" = 80'-0"

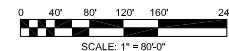

SCALE: 1" = 80'-0"

ARL: C:\19021\01\Drawings\Acad\MP-22 Stormwater Piping Near Term Future

Plotted By: Tyler Koell | 6/9/2022 11:40 AM



PROJECT NAME:  
**Montgomery College**



**GERMANTOWN**  
**CAMPUS**  
**UTILITY MASTER**  
**PLAN**

SEAL:

ISSUED FOR:

DATE:	DESCRIPTION:
JUNE 2022	FINAL

PROJECT NO: BKM # 19021.01  
 SCALE: AS NOTED  
 DRAWN BY: BKM  
 CHECKED BY: BKM  
 DATE: JUNE 2022

SHEET TITLE:  
**SITE PLAN - STORM SYSTEM**  
**LONG-TERM FUTURE**  
**(2035-BEYOND)**

DRAWING NO:  
**P1.23**  
 BKM# 19021.01



**1 SITE PLAN - STORM SYSTEM - LONG-TERM FUTURE (2035-BEYOND)**  
 SCALE: 1" = 80'-0"

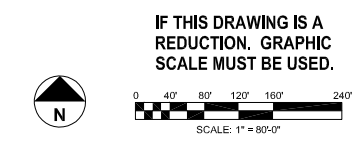

SEAL:

ISSUED FOR:

DATE:	DESCRIPTION:
JUNE 2022	FINAL

PROJECT NO: BKM # 19021.01

SCALE: AS NOTED

DRAWN BY: BKM

CHECKED BY: BKM

DATE: JUNE 2022

SHEET TITLE:  
**SITE PLAN**  
**NATURAL GAS**  
**EXISTING CONDITIONS**

DRAWING NO:  
**P1.31**  
 BKM# 19021.01



**1 SITE PLAN - NATURAL GAS - EXISTING CONDITIONS**  
 SCALE: 1" = 80'-0"

IF THIS DRAWING IS A  
 REDUCTION, GRAPHIC  
 SCALE MUST BE USED.

0 40' 80' 120' 160' 240'  
 SCALE: 1" = 80'-0"



SEAL:

ISSUED FOR:

DATE:	DESCRIPTION:
JUNE 2022	FINAL

PROJECT NO: BKM # 19021.01

SCALE: AS NOTED

DRAWN BY: BKM

CHECKED BY: BKM

DATE: JUNE 2022

SHEET TITLE:  
**SITE PLAN - NATURAL GAS**  
**NEAR-TERM FUTURE**  
**(2022-2034)**

DRAWING NO:  
**P1.32**

BKMF 19021.01

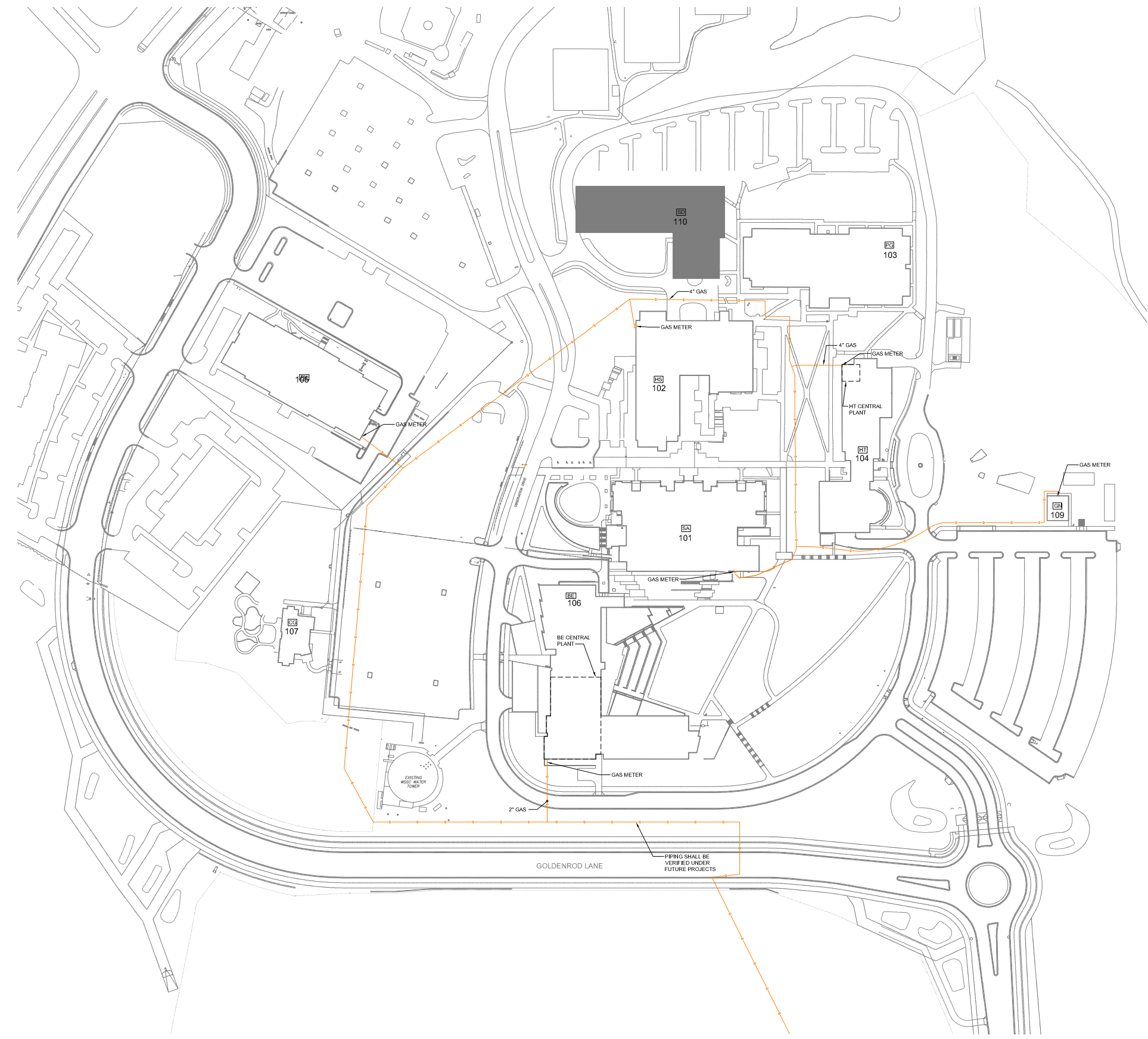

**1 SITE PLAN - NATURAL GAS - NEAR-TERM FUTURE (2022-2034)**  
 SCALE: 1" = 80'-0"

IF THIS DRAWING IS A REDUCTION, GRAPHIC SCALE MUST BE USED.

SCALE: 1" = 80'-0"

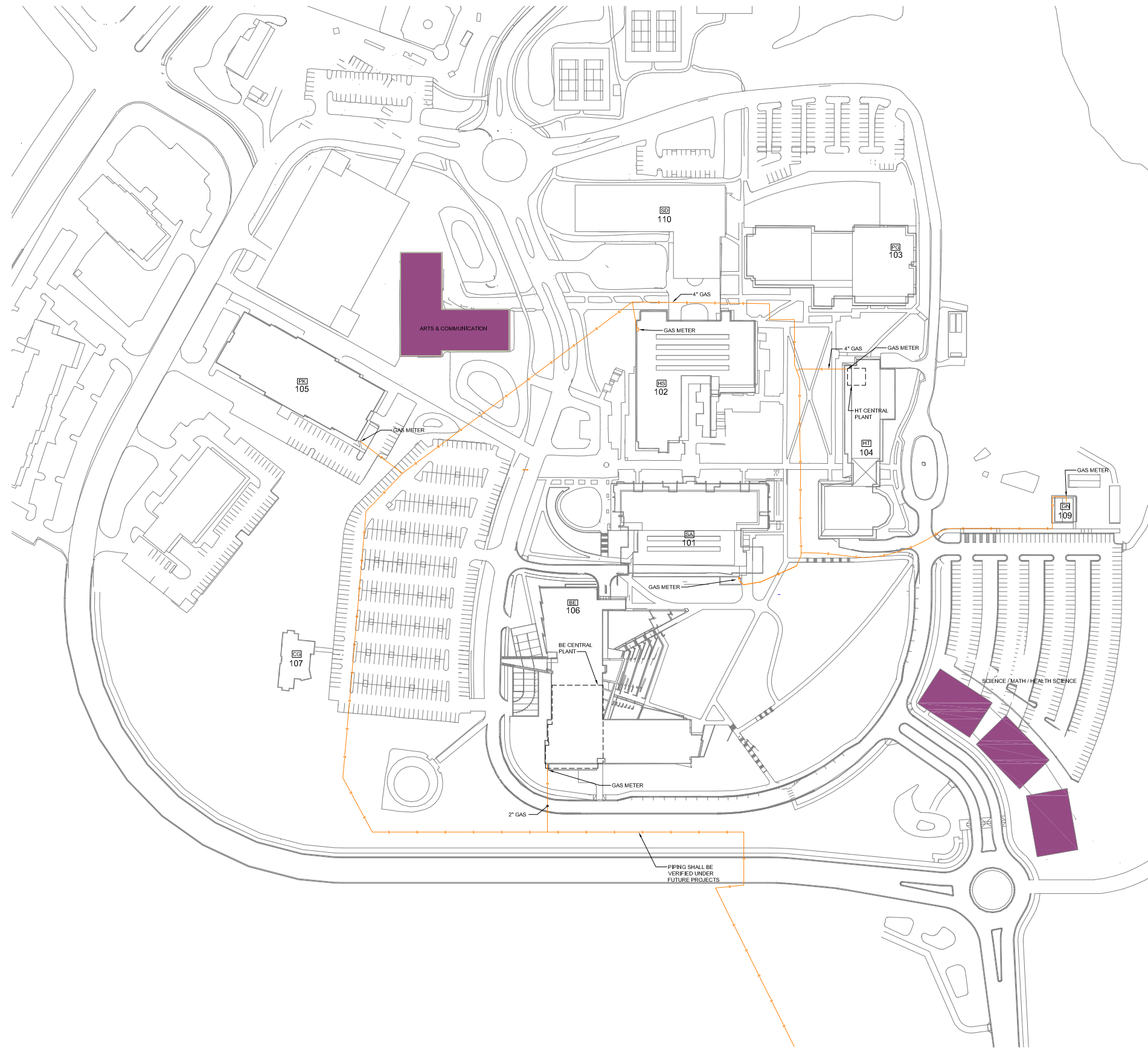

Plotted By: Tyler Koell | 6/9/2022 11:48 AM  
 ARJL-C:\19021.01\Drawings\Acad\MP-13 Natural Gas Piping Long Term Future

**1 SITE PLAN - NATURAL GAS - LONG-TERM FUTURE (2035-BEYOND)**  
 SCALE: 1" = 80'-0"



IF THIS DRAWING IS A  
 REDUCTION, GRAPHIC  
 SCALE MUST BE USED.  
 0 40' 80' 120' 160' 240'  
 SCALE: 1" = 80'-0"

**bkm**  
 Burdette, Koehler, Murphy & Associates, Inc.  
 Mechanical / Electrical Engineers  
 6301 Bell Hill Lane, Suite 400 | Baltimore, Maryland 21209  
 P: 410.323.0600 | www.bkma.com

PROJECT NAME:  
**Montgomery College**



Central Administration  
 Office of Facilities  
 9221 Corporate Boulevard  
 Rockville, MD 20850  
 Telephone: 240-567-7363

**GERMANTOWN  
 CAMPUS  
 UTILITY MASTER  
 PLAN**

SEAL:

ISSUED FOR:

DATE:	DESCRIPTION:
JUNE 2022	FINAL

PROJECT NO: BKM # 19021.01  
 SCALE: AS NOTED  
 DRAWN BY: BKM  
 CHECKED BY: BKM

DATE: JUNE 2022

SHEET TITLE:  
**SITE PLAN - NATURAL GAS  
 LONG-TERM FUTURE  
 (2035-BEYOND)**

DRAWING NO:  
**P1.33**

BKMF 19021.01

# bkm

---

Appendix 3  
Mechanical Systems

---

**TABLE 3-1 Cooling/Heating Loads - Existing Buildings**

Year Built	Bldg Abbrev	Bldg Number	Building Name	Bldg Area (GSF)	Cooling Estimated Load (Tons)	Cooling Load Factor (GSF/Ton)	Chiller Plant Capacity (Tons)	Heating Estimated Load (MBH)	Heating Load Factor (BTUH/GSF)	Boiler Plant Capacity (MBH)	Notes
<b>Central Plant (CP) Connected Loads</b>											
1978	SA	101	Science & Applied Studies	65,146	367	178	--	4,500	69	--	Renovation in Progress
1978	HS	102	Humanities & Social Sciences	75,700	235	322	--	2,271	30	3,870	
1983	PG	103	Physical Education	36,770	123	300	--	1,324	36	--	DX cooling only
1995	HT	104	High Technology & Science	75,542	319	237	570	2,780	30	3,870	
2012	CG	107	Child Care Center	5,535	20	277	--	450	81	--	
2014	BE	106	Bioscience Education	126,900	653	194	1,112	5,000	39	8,100	
Total Connected Load/Capacity				385,593	1,593	--	1,682	16,325	--	15,840	
Plant Capacity Surplus/(Shortage)				--	--	--	89	--	--	-485	
<b>Stand-Alone</b>											
1988	PK	105	Paul Peck Academic & Innovation	68,826	197	350	--	2,065	30	--	
2012	GN	109	Greenhouse	4,562	17	275	--	228	50	--	
Total Connected Load/Capacity				73,388	213	--	0	2,293	--	0	
Plant Capacity Surplus/(Shortage)				--	--	--	-213	--	--	-2,293	
<b>Total Campus Connected Load/Capacity</b>				<b>458,981</b>	<b>1,807</b>	<b>--</b>	<b>1,682</b>	<b>18,618</b>	<b>--</b>	<b>15,840</b>	
<b>Total Campus Diversified Load/Capacity</b>				<b>--</b>	<b>1,355</b>	<b>--</b>	<b>452</b>	<b>14,894</b>	<b>--</b>	<b>3,724</b>	<b>Based on 75% CHW, 80% HW Diversity</b>
<b>Total Campus Capacity Surplus/(Shortage)</b>				<b>--</b>	<b>--</b>	<b>--</b>	<b>-125</b>	<b>--</b>	<b>--</b>	<b>-2,778</b>	

**TABLE 3-2 Cooling/Heating Loads - Near-Term Future Buildings (2022-2034)**

Year Built	Year Renovated	Bldg Abbrev	Bldg Number	Building Name	Bldg Area (GSF)	Cooling Estimated Load (Tons)	Cooling Load Factor (GSF/Ton)	Chiller Plant Capacity (Tons)	Heating Estimated Load (MBH)	Heating Load Factor (BTUH/GSF)	Boiler Plant Capacity (MBH)	Notes
<b>Central Plant (CP) Connected Loads</b>												
1978	2020/2031 (2)	SA	101	Science & Applied Studies (Renovated)	118,248	367	322	--	4,500	38	--	18600 GSF Addition
1978		HS	102	Humanities & Social Sciences	75,700	235	322	--	2,271	30	3,870	
1983		PG	103	Physical Education	36,770	123	300	--	1,324	30	--	
1995		HT	104	High Technology & Science	75,542	319	237	1,140	2,780	30	3,870	CP Renovated 2027
2012		CG	107	Child Care Center	5,535	20	277	--	450	81	--	
2014		BE	106	Bioscience Education	126,900	653	194	1,112	5,000	39	8,100	
2029 (1)		SD	110	Student Services Center	153,660	515	300	515	6,150	40	8,000	New Satellite Plant 2027
Total Connected Load/Capacity					592,355	2,231	--	2,767	22,475	--	23,840	
Plant Capacity Surplus/(Shortage)					--	--	--	536	--	--	1,365	
<b>Stand-Alone</b>												
1988		PK	105	Paul Peck Academic & Innovation	68,826	197	350	--	2,065	30	--	
2012		GN	109	Greenhouse	4,562	17	275	--	228	50	--	
Total Connected Load/Capacity					73,388	213	--	0	2,293	--	0	
Plant Capacity Surplus/(Shortage)					--	--	--	-213	--	--	-2,293	
<b>Total Campus Connected Load/Capacity</b>					<b>665,743</b>	<b>2,444</b>	<b>--</b>	<b>2,767</b>	<b>24,768</b>	<b>--</b>	<b>23,840</b>	
<b>Total Campus Diversified Load/Capacity</b>					<b>--</b>	<b>1,833</b>	<b>--</b>	<b>934</b>	<b>19,814</b>	<b>--</b>	<b>4,954</b>	Based on 75% CHW, 80% HW Diversity
<b>Total Campus Capacity Surplus/(Shortage)</b>					<b>--</b>	<b>--</b>	<b>--</b>	<b>323</b>	<b>--</b>	<b>--</b>	<b>-928</b>	

\*\*Facility Master Plan 2013-2023 Projects

**TABLE 3-3 Cooling/Heating Loads - Long-Term Future Buildings (2035 - Beyond)**

Year Built	Year Renovated	Bldg Abbrev	Bldg Number	Building Name	Bldg Area (GSF)	Cooling Estimated Load (Tons)	Cooling Load Factor (GSF/Ton)	Chiller Plant Capacity (Tons)	Heating Estimated Load (MBH)	Heating Load Factor (BTUH/GSF)	Boiler Plant Capacity (MBH)	Notes
<b>Central Plant (CP) Connected Loads</b>												
1978	2020/2031 (2)	SA	101	Science & Applied Studies (Renovated)	118,248	367	322	--	4,500	38	--	
1978	2039 (4)	HS	102	Humanities & Social Sciences (Renovated)	75,700	252	300	--	2,271	30	--	Boilers Removed
1983	2078/2081 (10)	PG	103	Physical Education (Renovated)	73,270	244	300	--	2,198	30	--	36500 SF Addition
1995	2066 (8)	HT	104	High Technology & Science (Renovated)	82,142	319	258	1,140	2,464	30	--	Boilers Removed
2012		CG	107	Child Care Center	5,535	20	277	--	450	81	--	
2014		BE	106	Bioscience Education	126,900	653	194	1,112	5,000	39	8,100	
2029 (1)		SD	110	Student Service Center	153,660	515	300	515	6,150	40	16,000	Satellite Plant 2029, Boiler Plant Expanded ~2039
2054 (6)				Science/Math/Science Center	34,200	76	300		1,368	40		
2060 (7)				Arts and Communication	72,000	240	300		2,880	40		
Total Connected Load/Capacity					741,655	2,686	--	2,767	27,281	--	24,100	
Plant Capacity Surplus/(Shortage)					--	--	--	81	--	--	-3,181	
<b>Stand-Alone</b>												
1988	2072 (9)	PK	105	Paul Peck Academic & Innovation	68,826	197	350	--	2,065	30	--	
2012		GN	109	Greenhouse	4,562	17	275	--	228	50	--	
Total Connected Load/Capacity					73,388	213	--	0	2,293	--	0	
Plant Capacity Surplus/(Shortage)					--	--	--	-213	--	--	-2,293	
Total Campus Connected Load/Capacity					815,043	2,899	--	2,767	29,574	--	24,100	
Total Campus Diversified Load/Capacity					--	2,174	--	593	23,659	--	5,915	Based on 75% CHW, 80% HW Diversity
Total Campus Capacity Surplus/(Shortage)					--	--	--	-132	--	--	-5,474	

\*\*Facility Master Plan 2013-2023 Projects



**TABLE 3-4 Cooling Plants - Existing Equipment**

Tag	Unit	Manufacturer	Year Installed	Entering Water Temp (°F)	Leaving Water Temp (°F)	Pump Motor (HP)	Flow Rate (GPM)	Pressure (FT HD)	Cooling Tower Capacity (Tons)	Chiller Capacity (Tons)	Chiller Ice-build Capacity (Tons)	Ice Storage Latent Capacity (Tons-Hrs)	Heat Exchanger Capacity (Tons)
<b>High Technology (HT) Satellite Plant</b>													
CT-1	Cooling Tower, VFD	BAC	1995	95	85	--	750	--	340	--	--	--	--
CH-1	Ammonia Chiller	Frick	1995	38	30	--	806	--	--	265	220	--	--
CH-2	Ammonia Chiller (standby)	Frick	1999	38	30	--	806	--	--	265	220	--	--
IT-1	Ice Storage Module	BAC	1995	42	34	--	605	--	--	--	--	1,220	--
IT-2	Ice Storage Module	BAC	1995	42	34	--	605	--	--	--	--	1,220	--
DCHWP-1	Campus Chilled Water Pump	--	1996	--	--	60	1500	--	--	--	--	--	--
DCHWP-2	Campus Chilled Water Pump	--	1996	--	--	60	1500	--	--	--	--	--	--
CHWP-HT-1	Building Chilled Water Pump, VFD	Bell & Gossett	2015	--	--	15	624	50	--	--	--	--	--
CHWP-HT-2	Building Chilled Water Pump, VFD	Bell & Gossett	2015	--	--	15	624	50	--	--	--	--	--
GCHP-1	Glycol Water Pump	Bell & Gossett	1995	--	--	40	806	100	--	--	--	--	--
GCHP-2	Glycol Water Pump	Bell & Gossett	1995	--	--	40	806	100	--	--	--	--	--
SGCHP-1	Glycol Water Pump	TACO	1995	--	--	15	500	50	--	--	--	--	--
SGCHP-2	Glycol Water Pump	Bell & Gossett	1995	--	--	15	500	50	--	--	--	--	--
SGCHP-3	Glycol Water Pump, VFD	Bell & Gossett	1996	--	--	20	1150	50	--	--	--	--	--
CWP-1	Condenser Water	Bell & Gossett	1995	--	--	30	750	80	--	--	--	--	--
CWP-2	Condenser Water	Bell & Gossett	1995	--	--	30	750	80	--	--	--	--	--
HX-1	Glycol-Chilled Water Plate & Frame Heat Exchanger	--	1996	--	--	--	--	--	--	--	--	--	250
<b>Total HT Central Plant Equipment Capacity:</b>									<b>340</b>	<b>530</b>	<b>440</b>	<b>2,440</b>	<b>250</b>
<b>Bioscience (BE) Central Plant:</b>													
CT-1	Cooling Tower, VFD	BAC	2013	95	85		1861		775	--	--	--	--
CT-2	Cooling Tower, VFD	BAC	2013	95	85		1861		775	--	--	--	--
CH-BE-1	Ammonia Chiller	Frick	2013	54	38		600		--	338	250	--	--
CH-BE-2	Ammonia Chiller	Frick	2013	54	38		600		--	338	250	--	--
CH-BE-3	Electric 134a Chiller	Daikin McQuay	2013	56	40		540		--	360	--	--	--
TST-1	Ice Storage Module	BAC	2013				150		--	--	--	761	--
TST-2	Ice Storage Module	BAC	2013				150		--	--	--	761	--
TST-3	Ice Storage Module	BAC	2013				150		--	--	--	761	--
TST-4	Ice Storage Module	BAC	2013				150		--	--	--	761	--
TST-5	Ice Storage Module	BAC	2013				150		--	--	--	761	--
TST-6	Ice Storage Module	BAC	2013				150		--	--	--	761	--
TST-7	Ice Storage Module	BAC	2013				150		--	--	--	761	--
TST-8	Ice Storage Module	BAC	2013				150		--	--	--	761	--
GCWHP-BE-1	Glycol Water Pump, VFD	Bell & Gossett	2015			25	600	95					
GCWHP-BE-2	Glycol Water Pump, VFD	Bell & Gossett	2015			25	600	95					
GCWHP-BE-3	Glycol Water Pump (standby), VFD	Bell & Gossett	2015			25	600	95					
CWHP-BE-1	Chilled Water Pump, VFD	Bell & Gossett	2013			40	834	110					
CWHP-BE-2	Chilled Water Pump, VFD	Bell & Gossett	2013			40	834	110					
CWHP-BE-3	Secondary Chilled Water Pump, VFD	Bell & Gossett	2013			25	490	80					
CWHP-BE-4	Secondary Chilled Water Pump, VFD	Bell & Gossett	2013			25	490	80					
CWP-BE-1	Condenser Water, VFD	Bell & Gossett	2015			25	1100	85					
CWP-BE-2	Condenser Water, VFD	Bell & Gossett	2015			25	1100	85					
CWP-BE-3	Condenser Water, VFD	Bell & Gossett	2015			25	1100	85					
CWP-BE-4	Condenser Water (standby), VFD	Bell & Gossett	2015			25	1100	85					
HX-1	Glycol-Chilled Water Plate & Frame Heat Exchanger	--	2013				1200		--	--		--	800
<b>Total BE Central Plant Equipment Capacity:</b>									<b>1,551</b>	<b>1,036</b>	<b>500</b>	<b>6,088</b>	<b>800</b>
<b>Total HT Central Plant Cooling Capacity:</b>									<b>570</b>	<b>Note 1</b>			
<b>Total BE Central Plant Cooling Capacity:</b>									<b>1,112</b>	<b>Note 2 &amp; 3</b>			
<b>Total Campus Chilled Water System Capacity:</b>									<b>1,682</b>				

- Notes:
- (1) Cooling Tower is limiting factor in plant capacity
  - (2) Chilled Water Pumps are limiting factor for plant capacity
  - (3) Based on HX-1 capacity with 124 tons from ice melt & CH-BE-3 operating

**TABLE 3-5 Heating Plants - Existing Equipment**

Tag	Unit	Manufacturer	Year Installed	Entering Water Temp (F°)	Leaving Water Temp (F°)	Pump Motor (HP)	Flow (GPM)	Pressure (FT HD)	ΔT (°F)	Boiler Capacity (MBH Output)
<b>High Technology (HT) Satellite Plant</b>										
B-1	Benchmark 1.5LN	Aerco	2013	140	160	--	129	--	20	1,290
B-2	Benchmark 1.5LN	Aerco	2013	140	160	--	129	--	20	1,290
B-3	Benchmark 1.5LN	Aerco	2013	140	160	--	129	--	20	1,290
HWP-1	Heating Water Pump	--	1993	--	--	--	300	30	--	--
HWP-2	Heating Water Pump	--	1993	--	--	--	300	30	--	--
SHWP-1	Heating Water Pump	--	1993	--	--	7.5	278	50	--	--
SHWP-2	Heating Water Pump	--	1993	--	--	7.5	278	50	--	--
<b>Total HT Satellite Plant Equipment Capacity:</b>										<b>3,870</b>
<b>Humanities (HS) Satellite Plant:</b>										
B-1	Benchmark 1.5LN	Aerco	2013	140	160	--	129	--	20	1,290
B-2	Benchmark 1.5LN	Aerco	2013	140	160	--	129	--	20	1,290
B-3	Benchmark 1.5LN	Aerco	2013	140	160	--	129	--	20	1,290
P-1	Heating Water Pump	Taco	--	--	--	10	--	45	--	--
P-2	Heating Water Pump	Taco	--	--	--	10	--	45	--	--
	Heating Water Pump	Bell & Gossett	2013	--	--	5	190	45	--	--
	Heating Water Pump	Bell & Gossett	2013	--	--	5	190	45	--	--
<b>Total HS Satellite Plant Equipment Capacity:</b>										<b>3,870</b>
<b>Bioscience (BE) Central Plant:</b>										
B-1	Boiler	Aerco	2013	160	180	--	243	--	20	2,700
B-2	Boiler	Aerco	2013	160	180	--	243	--	20	2,700
B-3	Boiler	Aerco	2013	160	180	--	243	--	20	2,700
HWP-BE-1	Heating Water Pump, VFD	Bell & Gossett	2013	--	--	20	500	80	--	--
HWP-BE-2	Heating Water Pump (standby), VFD	Bell & Gossett	2013	--	--	20	500	80	--	--
HWP-BE-3	Campus Heating Water Pump, VFD	Bell & Gossett	2013	--	--	40	810	110	--	--
HWP-BE-4	Campus Heating Water Pump (standby), VFD	Bell & Gossett	2013	--	--	40	810	110	--	--
<b>Total BE Central Plant Equipment Capacity:</b>										<b>8,100</b>
Total HT Satellite Plant Heating Capacity: 3,870 Total HS Satellite Plant Heating Capacity: 3,870 Total BE Central Plant Heating Capacity: 8,100 <b>Total Campus Heating Water System Capacity: 15,840</b>										

### Chart 3-1 - Campus Cooling Load vs Cooling Capacity

June 2022

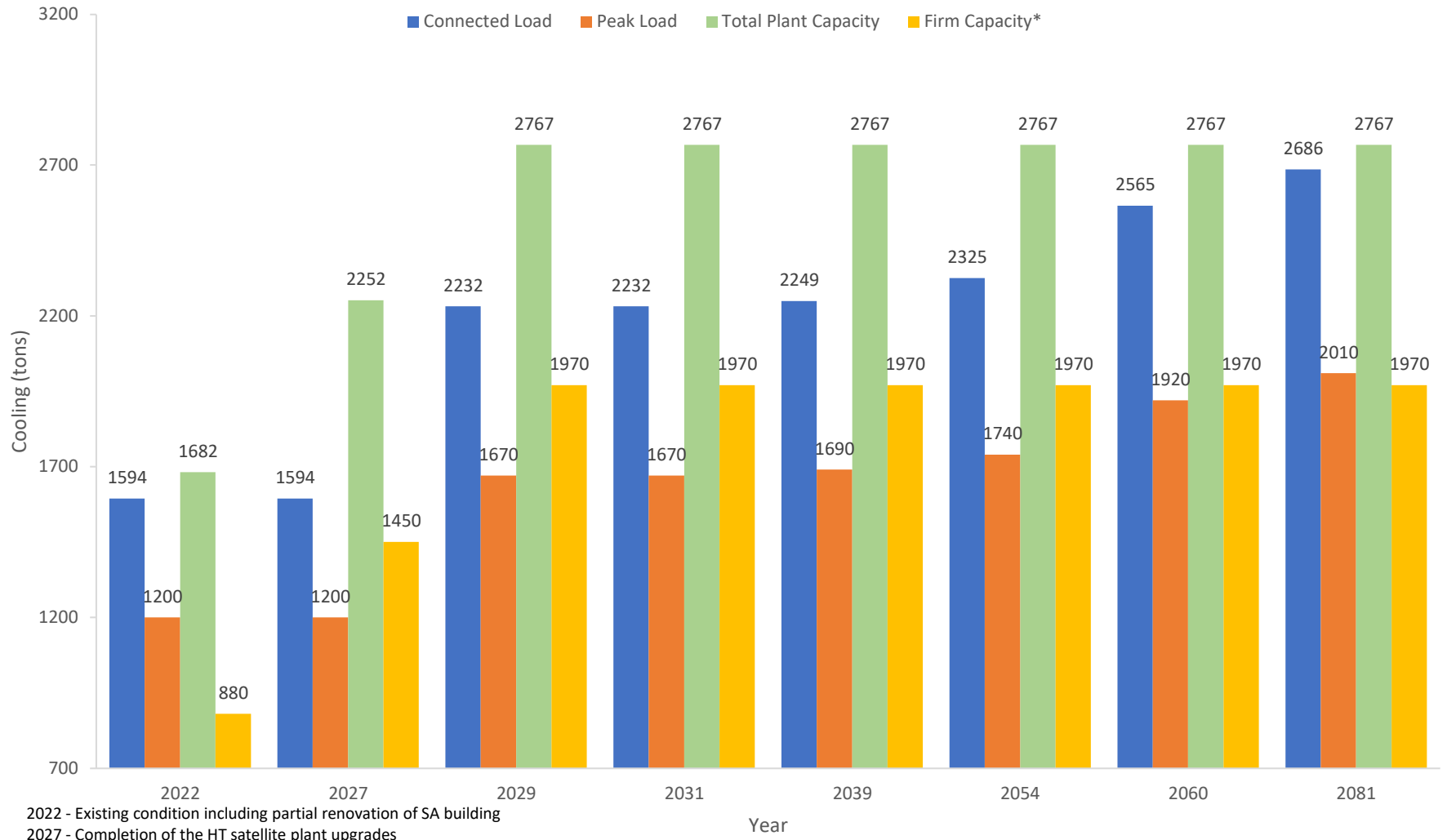

2022 - Existing condition including partial renovation of SA building

2027 - Completion of the HT satellite plant upgrades

2029 - Completion of the new Student Services Center

2031 - Completion of SA Renovations

2039 - Completion of HS Renovations

2054 - Completion of the new Science/Math/Science Center

2060 - Completion of the Arts & Communication building

2081 - Completion of the addition to PG building

\*Firm capacity assumes the loss of the 800-ton glycol to chilled water heat exchanger (HEX-1) at BE which results in the subsequent loss of 800 tons of cooling via ice melt

### Chart 3-2 - Campus Heating Load vs Heating Capacity

June 2022

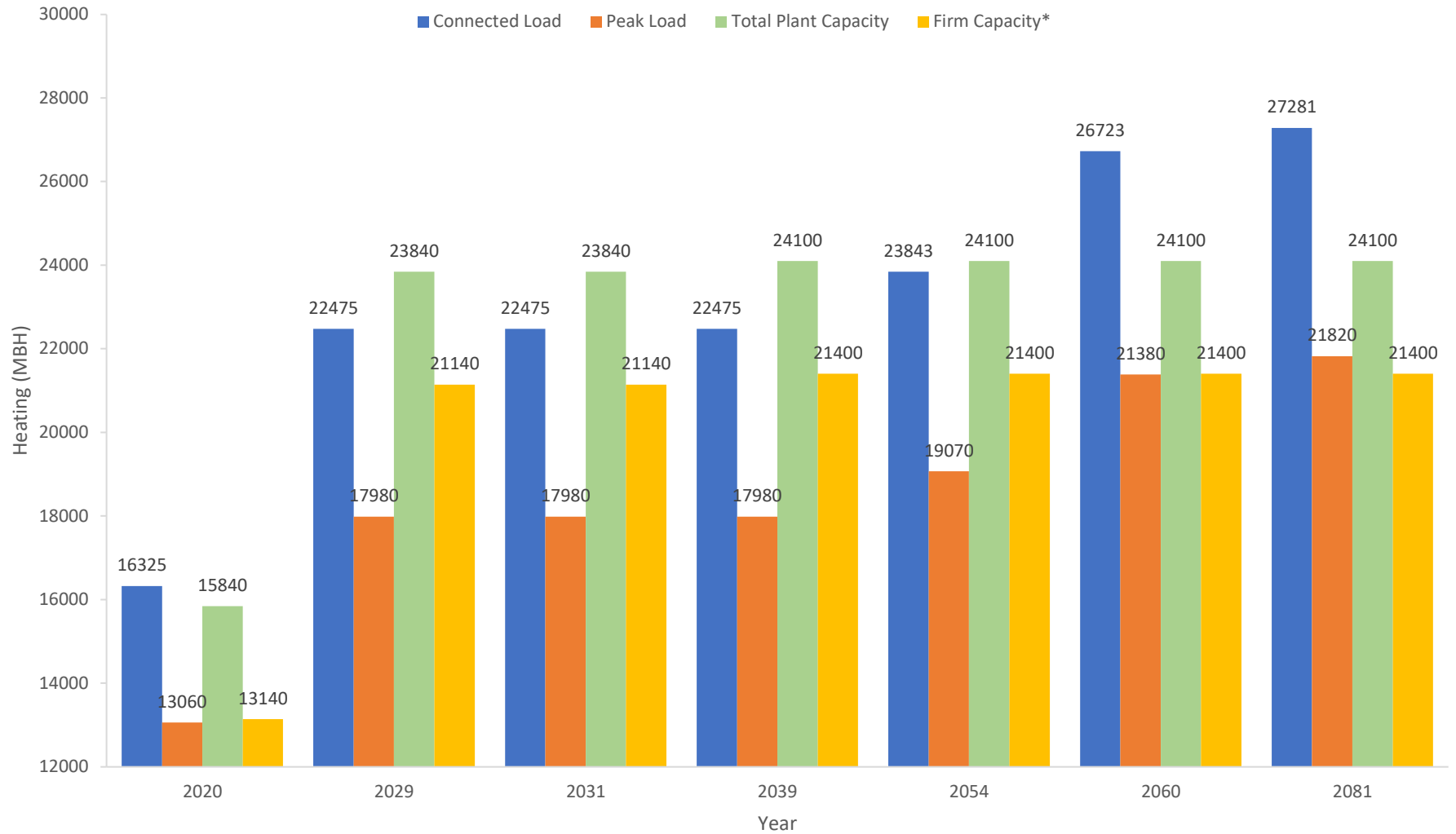

2020 - Existing condition including partial renovation of SA building  
 2029 - Completion of the new Student Services Center  
 2031 - Completion of the SA renovation  
 2039 - Completion of the HS revovation, expansion of Satellite heating plant  
 2054 - Completion of the new Science/Math/Science Center  
 2060 - Completion of the Arts & Communication building  
 2081 - Completion of the addition to PG building  
 \*Firm capacity assumes the loss of a 2,700 MBH boiler at BE

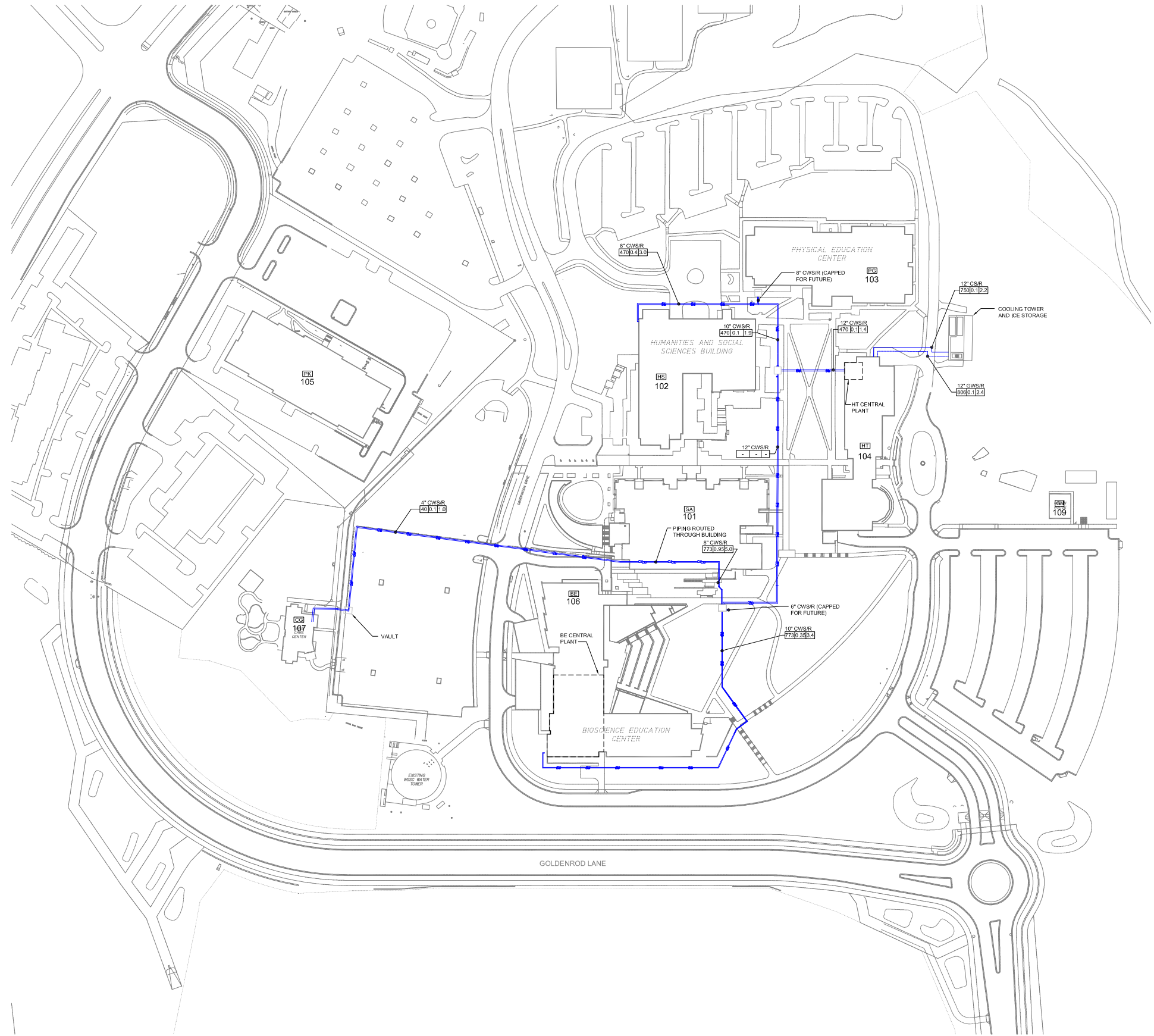

Pinned By: Tyler Koel | 6/10/2022 10:37 AM  
 ARL C:\119021\11\Drawings\Acad\MM10\Chilled Water Piping Existing

**LEGEND:**

FLOW RATE	WATER PRESSURE	VELOCITY
GPM	FT HD/100 LF	FPS



IF THIS DRAWING IS A REDUCTION, GRAPHIC SCALE MUST BE USED.  
 0 40' 80' 120' 160' 240'  
 SCALE: 1" = 80'-0"

**1 SITE PLAN - CHILLED WATER SYSTEM - EXISTING CONDITIONS**  
 SCALE: 1" = 80'-0"

PROJECT NAME:  
**Montgomery College**



**GERMANTOWN CAMPUS  
 UTILITY MASTER PLAN**

SEAL:

ISSUED FOR:

DATE:	DESCRIPTION:
JUNE 2022	FINAL

PROJECT NO: BKM # 19021.01

SCALE: AS NOTED

DRAWN BY: BKM

CHECKED BY: BKM

DATE: JUNE 2022

SHEET TITLE:  
**SITE PLAN  
 CHILLED WATER SYSTEM  
 EXISTING CONDITIONS**

DRAWING NO:  
**M1.01**  
 BKM# 19021.01

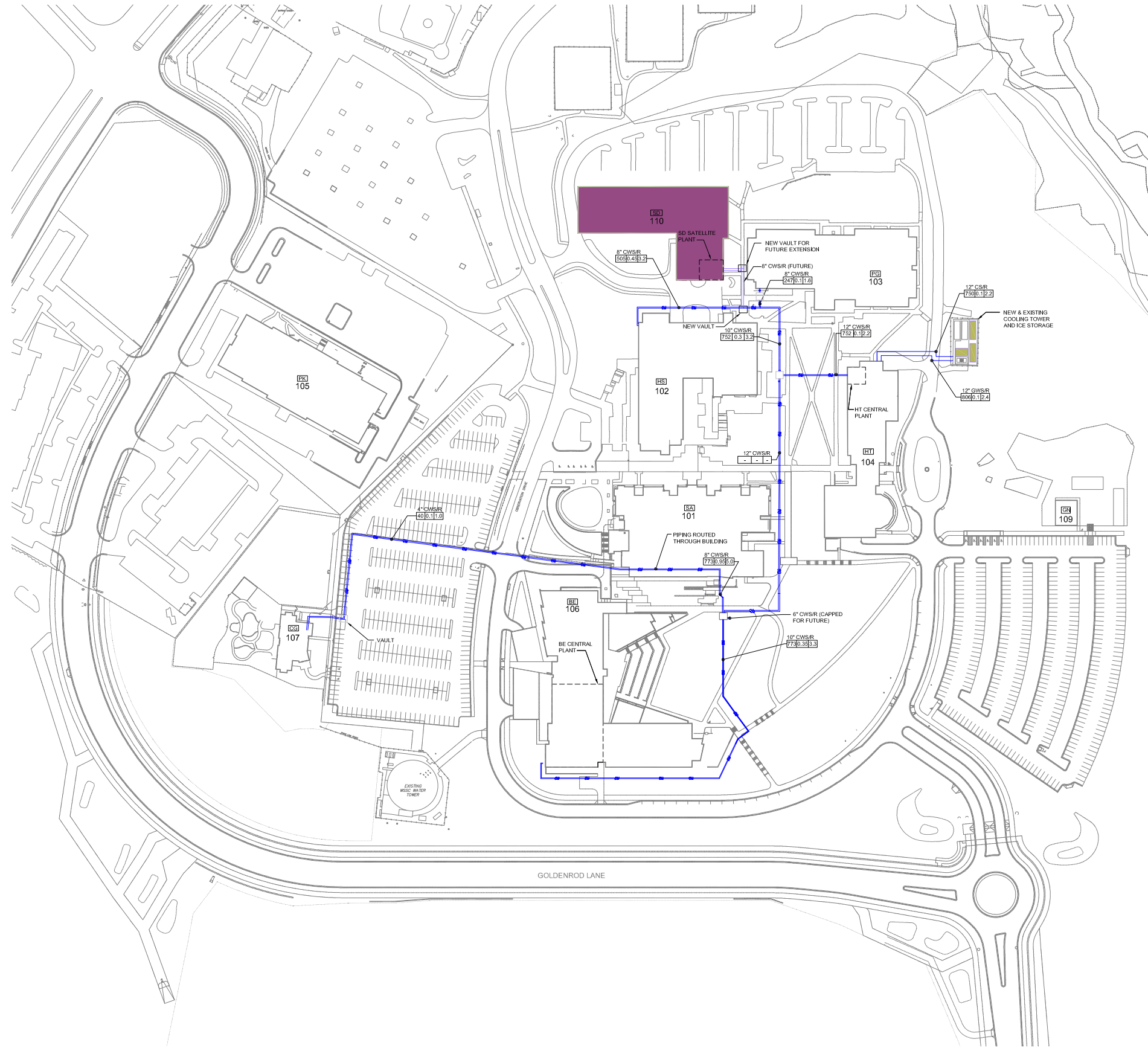

**LEGEND:**

FLOW RATE	WATER PRESSURE	VELOCITY
GPM	FT HD/100 LF	FPS

IF THIS DRAWING IS A REDUCTION, GRAPHIC SCALE MUST BE USED.

SCALE: 1" = 80'-0"



**1 SITE PLAN - CHILLED WATER SYSTEM - NEAR-TERM FUTURE (2022-2034)**  
SCALE: 1" = 80'-0"

**bkm**  
Burdette, Koehler, Murphy & Associates, Inc.  
Mechanical/Electrical Engineers  
6201 Bell Hill Lane, Suite 400 | Baltimore, Maryland 21209  
P: 410.323.0600 | www.bkma.com

PROJECT NAME:  
**Montgomery College**



**GERMANTOWN CAMPUS  
UTILITY MASTER PLAN**

SEAL:

ISSUED FOR:

DATE:	DESCRIPTION:
JUNE 2022	FINAL

PROJECT NO: BKM # 19021.01  
SCALE: AS NOTED  
DRAWN BY: BKM  
CHECKED BY: BKM

DATE: JUNE 2022

SHEET TITLE:  
**SITE PLAN - CHILLED WATER SYSTEM - NEAR-TERM FUTURE (2022-2034)**

DRAWING NO:  
**M1.02**

BKMF 19021.01

PROJECT NAME:  
**Montgomery College**



**GERMANTOWN**  
**CAMPUS**  
**UTILITY MASTER**  
**PLAN**

SEAL:

ISSUED FOR:

DATE:	DESCRIPTION:
JUNE 2022	FINAL

PROJECT NO: BKM # 19021.01  
 SCALE: AS NOTED  
 DRAWN BY: BKM  
 CHECKED BY: BKM  
 DATE: JUNE 2022

SHEET TITLE:  
**SITE PLAN - CHILLED WATER SYSTEM - LONG-TERM FUTURE (2035-BEYOND)**

DRAWING NO:  
**M1.03**  
 BKM# 19021.01

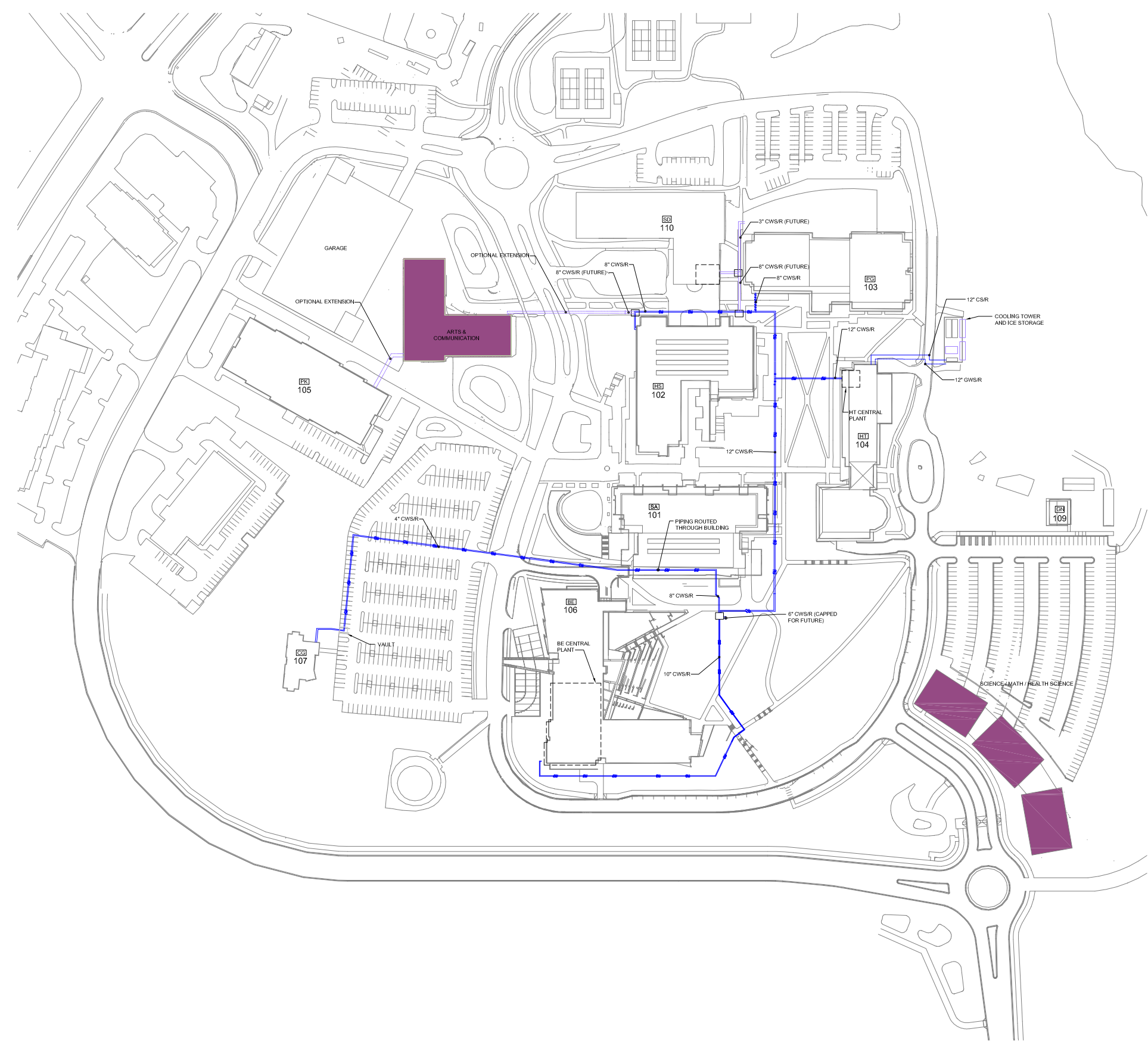

**LEGEND:**

FLOW RATE	WATER PRESSURE	VELOCITY
GPM	FT HD/100 LF	FPS

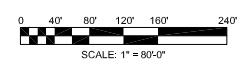

IF THIS DRAWING IS A REDUCTION, GRAPHIC SCALE MUST BE USED.

**1 SITE PLAN - CHILLED WATER SYSTEM - LONG-TERM FUTURE (2035-BEYOND)**  
 SCALE: 1" = 80'-0"

SEAL:

ISSUED FOR:

DATE:	DESCRIPTION:
JUNE 2022	FINAL

PROJECT NO: BKM # 19021.01

SCALE: AS NOTED

DRAWN BY: BKM

CHECKED BY: BKM

DATE: JUNE 2022

SHEET TITLE:  
**SITE PLAN**  
**HEATING WATER SYSTEM**  
**EXISTING CONDITIONS**

DRAWING NO:  
**M1.11**  
 BKM# 19021.01

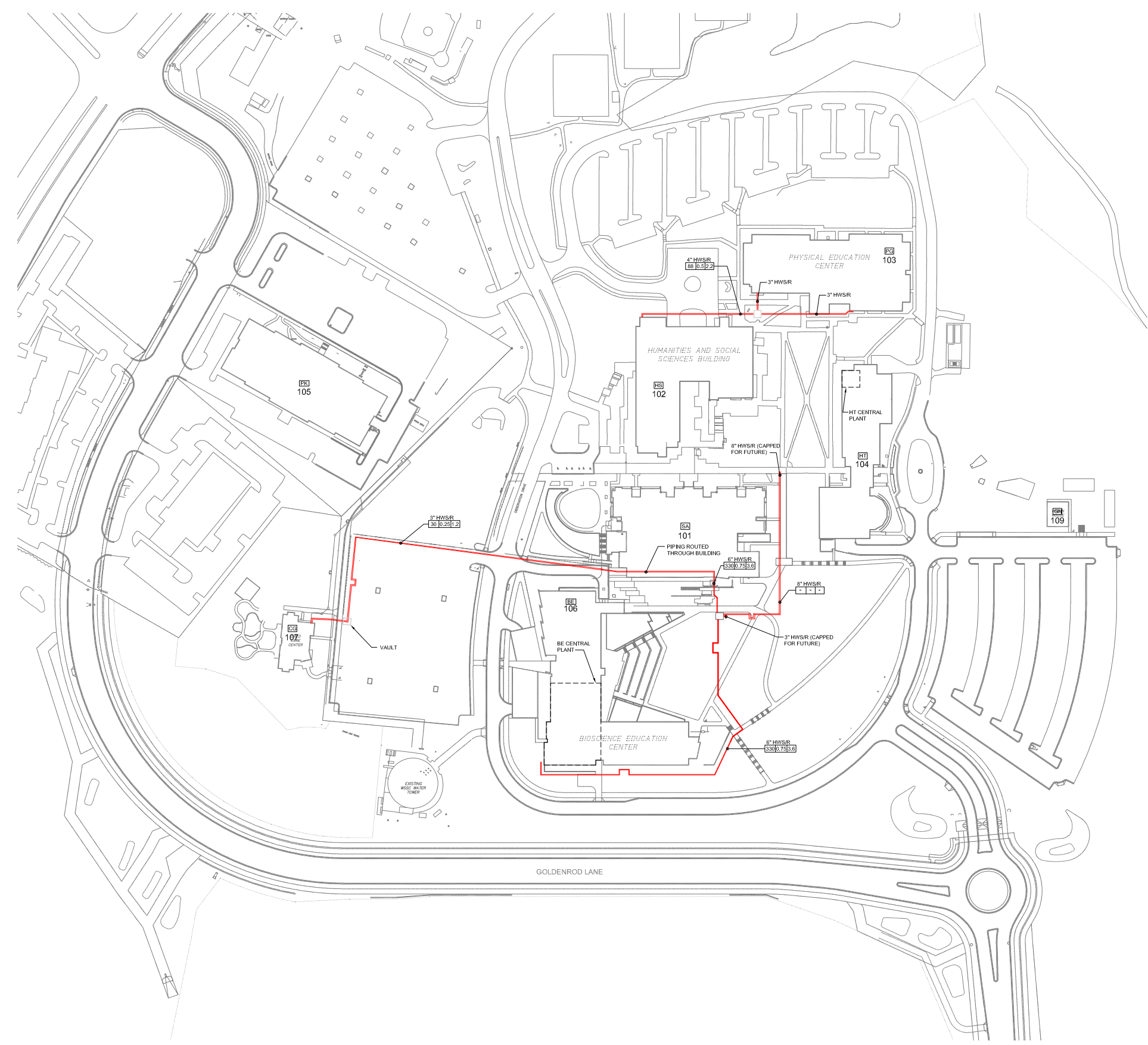

**LEGEND:**

FLOW RATE	WATER PRESSURE	VELOCITY
GPM	FT HD/100 LF	FPS



IF THIS DRAWING IS A  
 REDUCTION, GRAPHIC  
 SCALE MUST BE USED.

SCALE: 1" = 80'-0"

**1 SITE PLAN - HEATING WATER SYSTEM - EXISTING CONDITIONS**  
 SCALE: 1" = 80'-0"



PROJECT NAME:  
**Montgomery College**



**GERMANTOWN**  
**CAMPUS**  
**UTILITY MASTER**  
**PLAN**

SEAL:

ISSUED FOR:

DATE:	DESCRIPTION:
JUNE 2022	FINAL

PROJECT NO: BKM # 19021.01

SCALE: AS NOTED

DRAWN BY: BKM

CHECKED BY: BKM

DATE: JUNE 2022

SHEET TITLE:

**SITE PLAN - HEATING WATER**  
**SYSTEM - NEAR-TERM FUTURE**  
**(2022-2034)**

DRAWING NO:  
**M1.12**  
 BKM# 19021.01

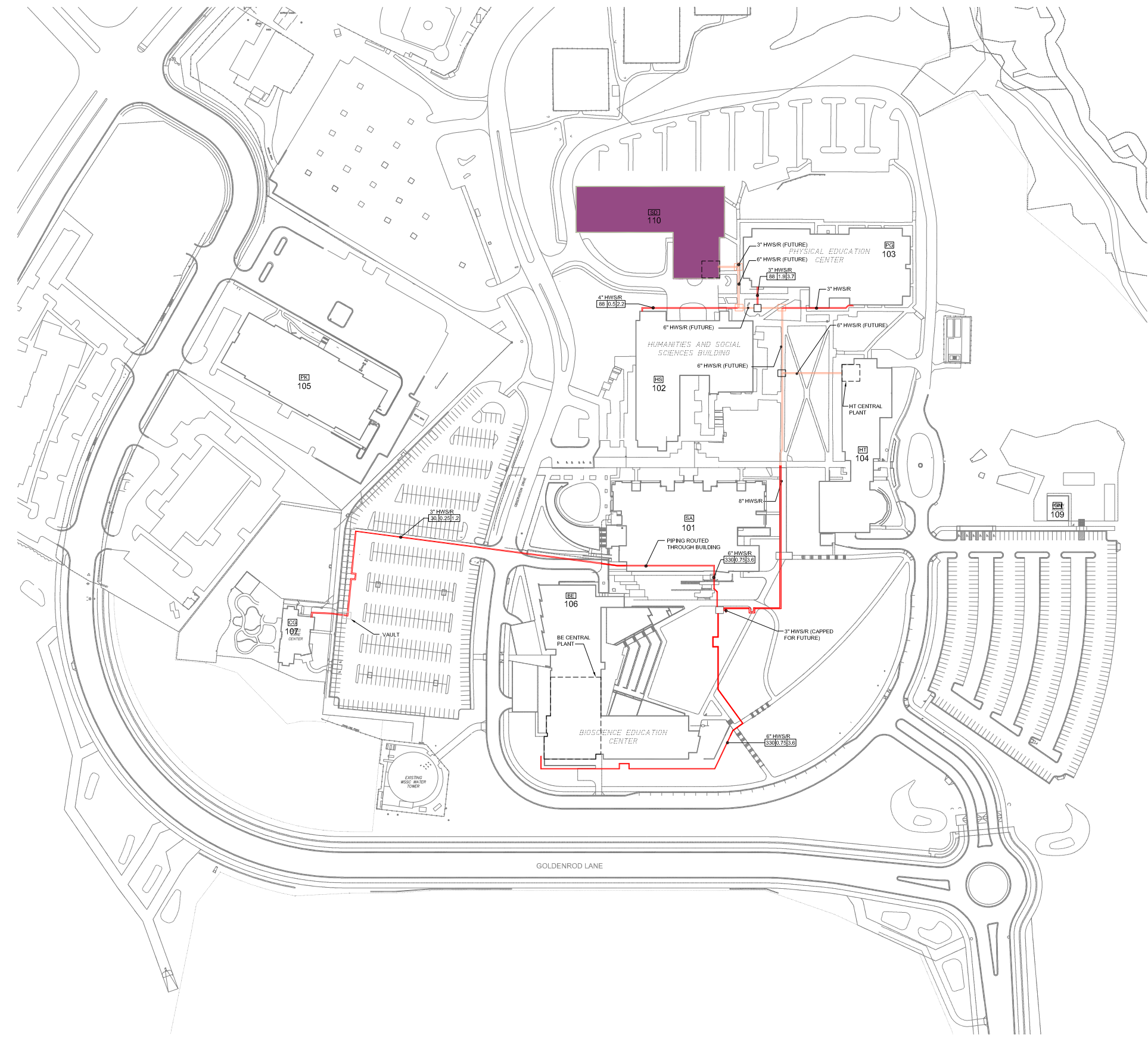

**LEGEND:**

FLOW RATE	WATER PRESSURE	VELOCITY
GPM	FT HD/100 LF	FPS

IF THIS DRAWING IS A  
 REDUCTION, GRAPHIC  
 SCALE MUST BE USED.

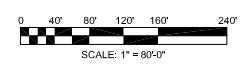

**1 SITE PLAN - HEATING WATER SYSTEM - NEAR-TERM FUTURE (2022-2034)**  
 SCALE: 1" = 80'-0"

SEAL:

ISSUED FOR:

DATE:	DESCRIPTION:
JUNE 2022	FINAL

PROJECT NO: BKM # 19021.01

SCALE: AS NOTED

DRAWN BY: BKM

CHECKED BY: BKM

DATE: JUNE 2022

SHEET TITLE:  
**SITE PLAN - HEATING WATER**  
**SYSTEM - LONG-TERM FUTURE**  
**(2035-BEYOND)**

DRAWING NO:  
**M1.13**  
 BKM# 19021.01

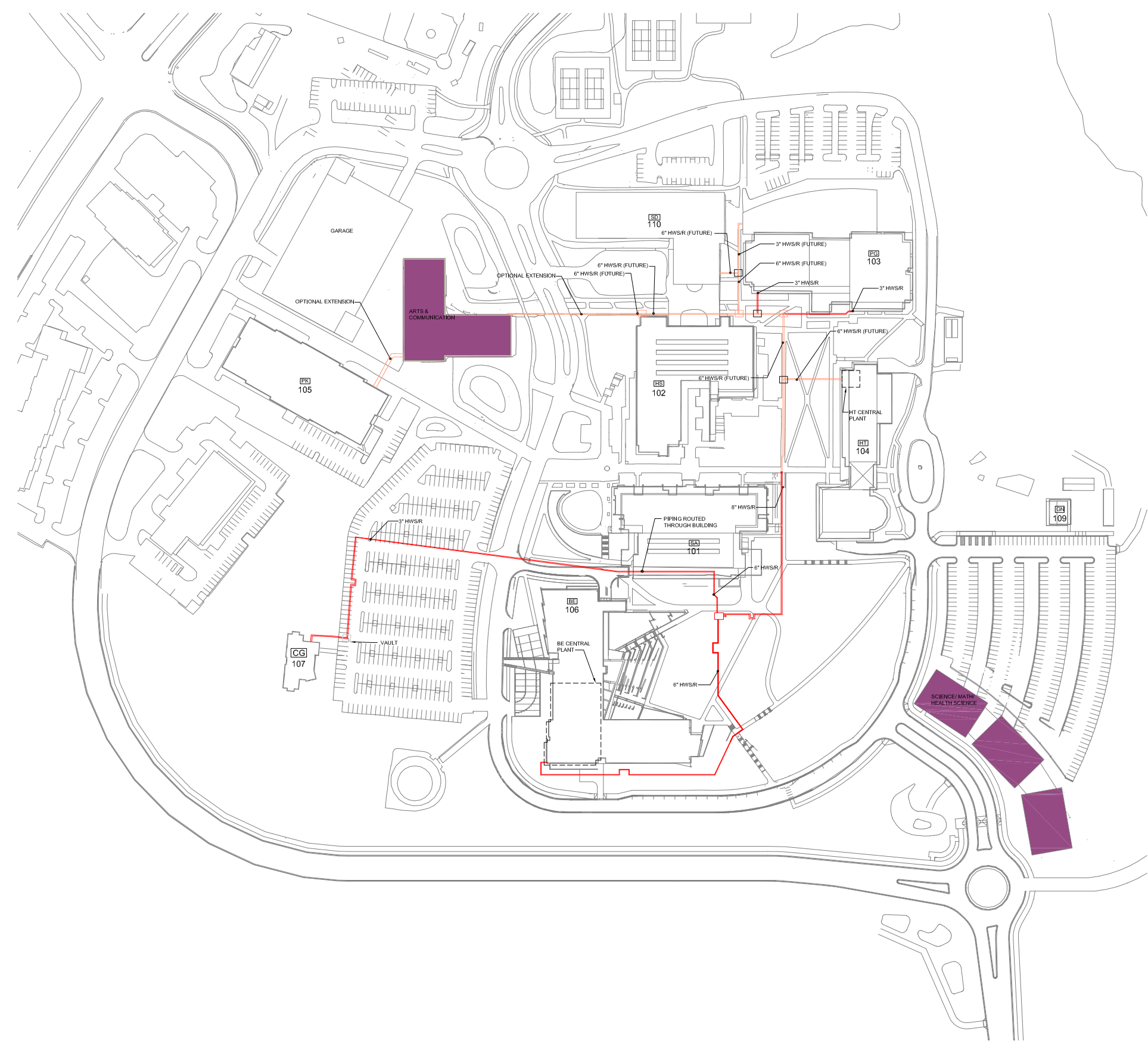

**LEGEND:**

FLOW RATE	WATER PRESSURE	VELOCITY
GPM	FT HD/100 LF	FPS

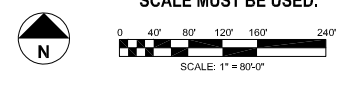

**1 SITE PLAN - HEATING WATER SYSTEM - LONG-TERM FUTURE (2035-BEYOND)**  
 SCALE: 1" = 80'-0"

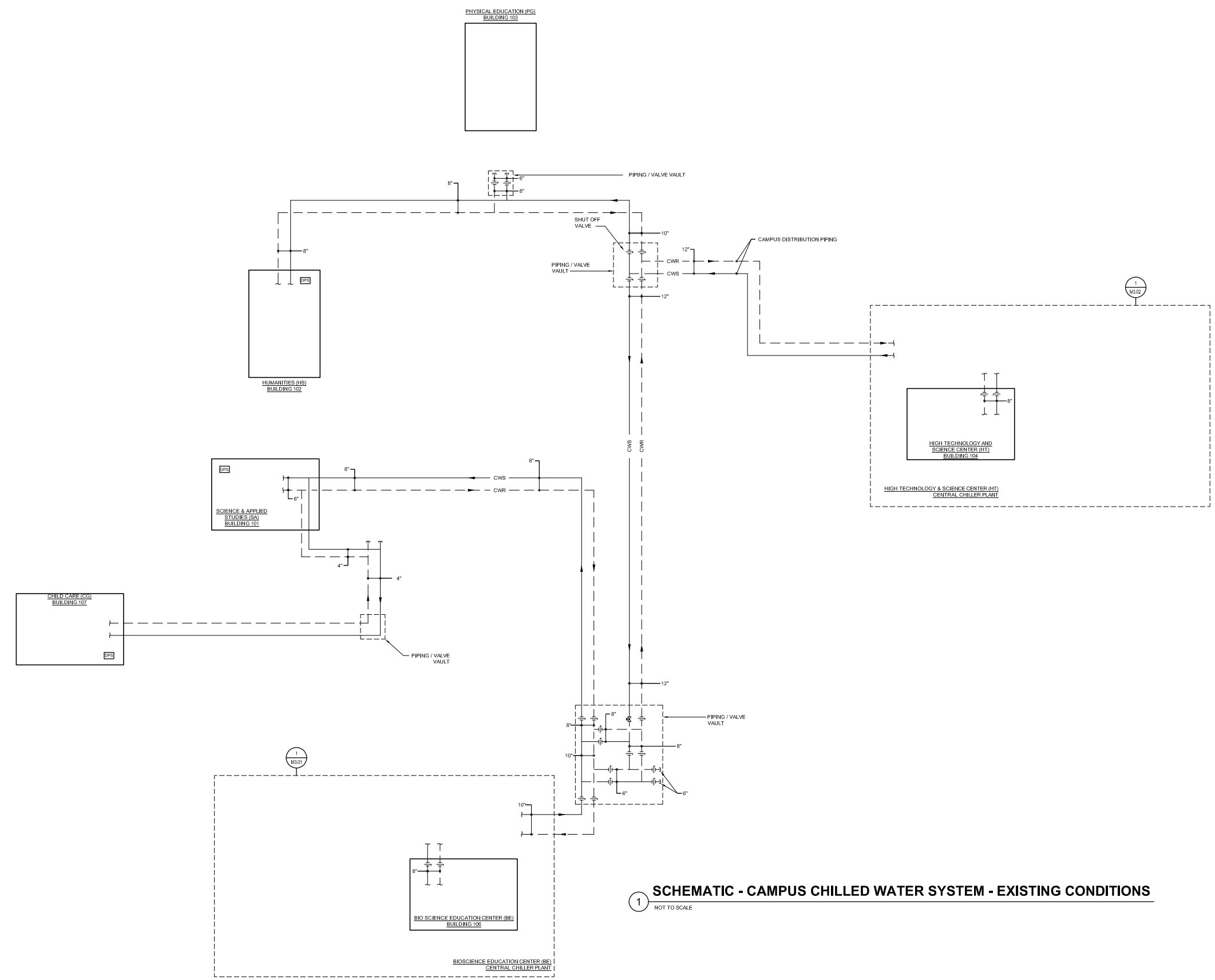

**1 SCHEMATIC - CAMPUS CHILLED WATER SYSTEM - EXISTING CONDITIONS**  
 NOT TO SCALE

SEAL:

ISSUED FOR:

DATE:	DESCRIPTION:
JUNE 2022	FINAL

PROJECT NO: BKM # 19021.01  
 SCALE: AS NOTED  
 DRAWN BY: CS  
 CHECKED BY: JMM  
 DATE: JUNE 2022

SHEET TITLE:  
**SCHEMATIC - CAMPUS CHILLED WATER SYSTEM EXISTING CONDITIONS**

DRAWING NO:  
**M2.01**

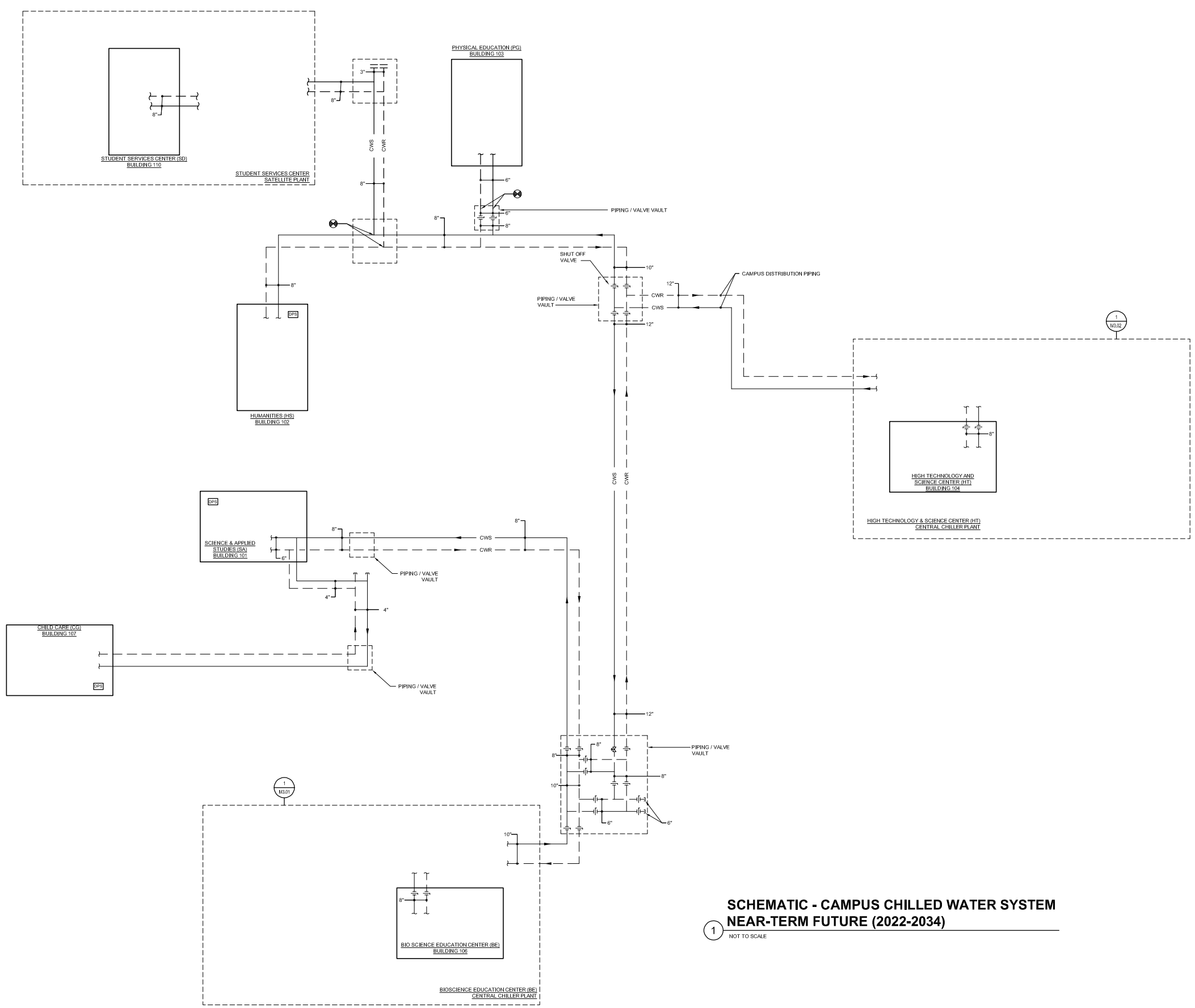

**SCHEMATIC - CAMPUS CHILLED WATER SYSTEM  
 NEAR-TERM FUTURE (2022-2034)**

1 NOT TO SCALE

SEAL:

ISSUED FOR:

DATE:	DESCRIPTION:
JUNE 2022	FINAL

PROJECT NO: BKM # 19021.01  
 SCALE: AS NOTED  
 DRAWN BY: CS  
 CHECKED BY: JMM  
 DATE: JUNE 2022

SHEET TITLE:  
**SCHEMATIC - CAMPUS  
 CHILLED WATER SYSTEM  
 NEAR-TERM FUTURE**

DRAWING NO:  
**M2.02**

SEAL:

ISSUED FOR:

DATE:	DESCRIPTION:
JUNE 2022	FINAL

PROJECT NO: BKM # 19021.01

SCALE: AS NOTED

DRAWN BY: SY

CHECKED BY: BKM

DATE: JUNE 2022

SHEET TITLE:  
**SCHEMATIC - CAMPUS HEATING WATER SYSTEM EXISTING CONDITIONS**

DRAWING NO:

**M2.11**

BKMF 19021.01

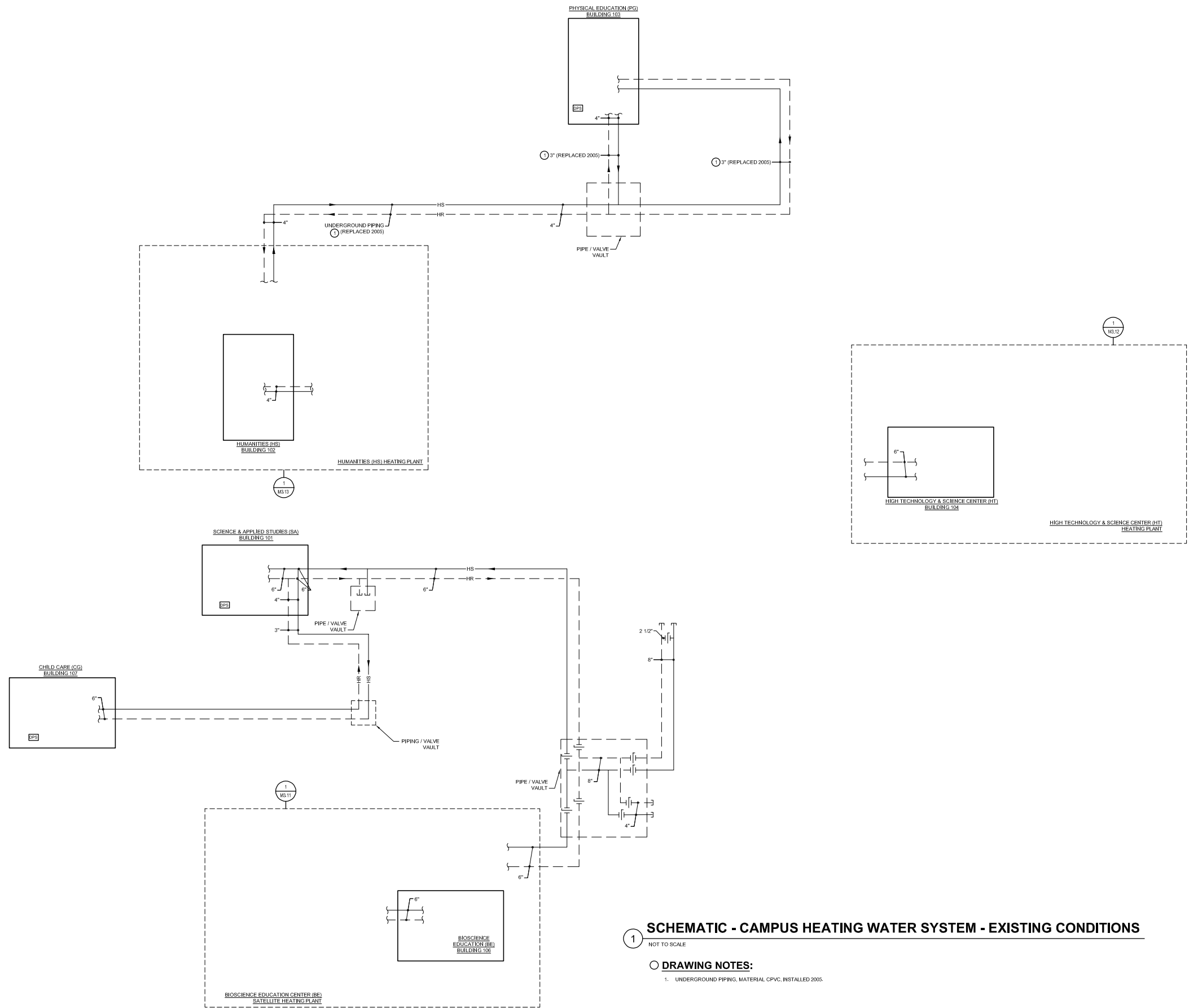

**1 SCHEMATIC - CAMPUS HEATING WATER SYSTEM - EXISTING CONDITIONS**  
 NOT TO SCALE

**DRAWING NOTES:**

1. UNDERGROUND PIPING, MATERIAL CPVC, INSTALLED 2005.

SEAL:

ISSUED FOR:

DATE:	DESCRIPTION:
JUNE 2022	FINAL

PROJECT NO: BKM # 19021.01

SCALE: AS NOTED

DRAWN BY: SY

CHECKED BY: BKM

DATE: JUNE 2022

SHEET TITLE:  
**SCHEMATIC - CAMPUS HEATING WATER SYSTEM NEAR-TERM FUTURE (2022-2034)**

DRAWING NO:  
**M2.12**  
 BKM# 19021.01

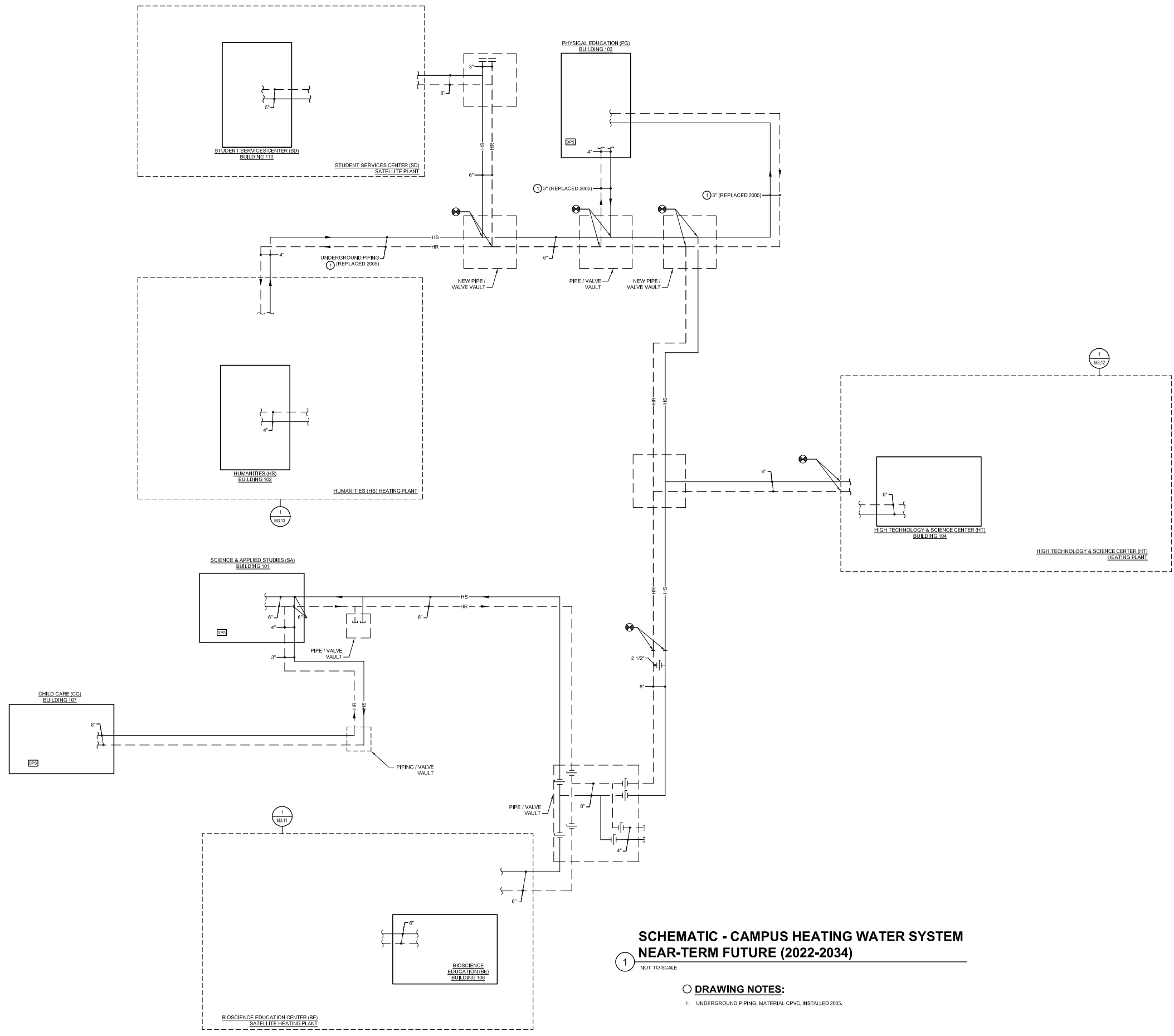

**SCHEMATIC - CAMPUS HEATING WATER SYSTEM NEAR-TERM FUTURE (2022-2034)**

- DRAWING NOTES:**
1. UNDERGROUND PIPING, MATERIAL CPVC, INSTALLED 2005.

SEAL:

ISSUED FOR:

DATE:	DESCRIPTION:
JUNE 2022	FINAL

PROJECT NO: BKM # 19021.01  
SCALE: AS NOTED  
DRAWN BY: SY  
CHECKED BY: JMM  
DATE: JUNE 2022

SHEET TITLE:  
**SCHEMATIC - (BE)**  
**CHILLED WATER SYSTEM**  
**EXISTING CONDITIONS**

DRAWING NO:  
**M3.01**  
BKM# 19021.01

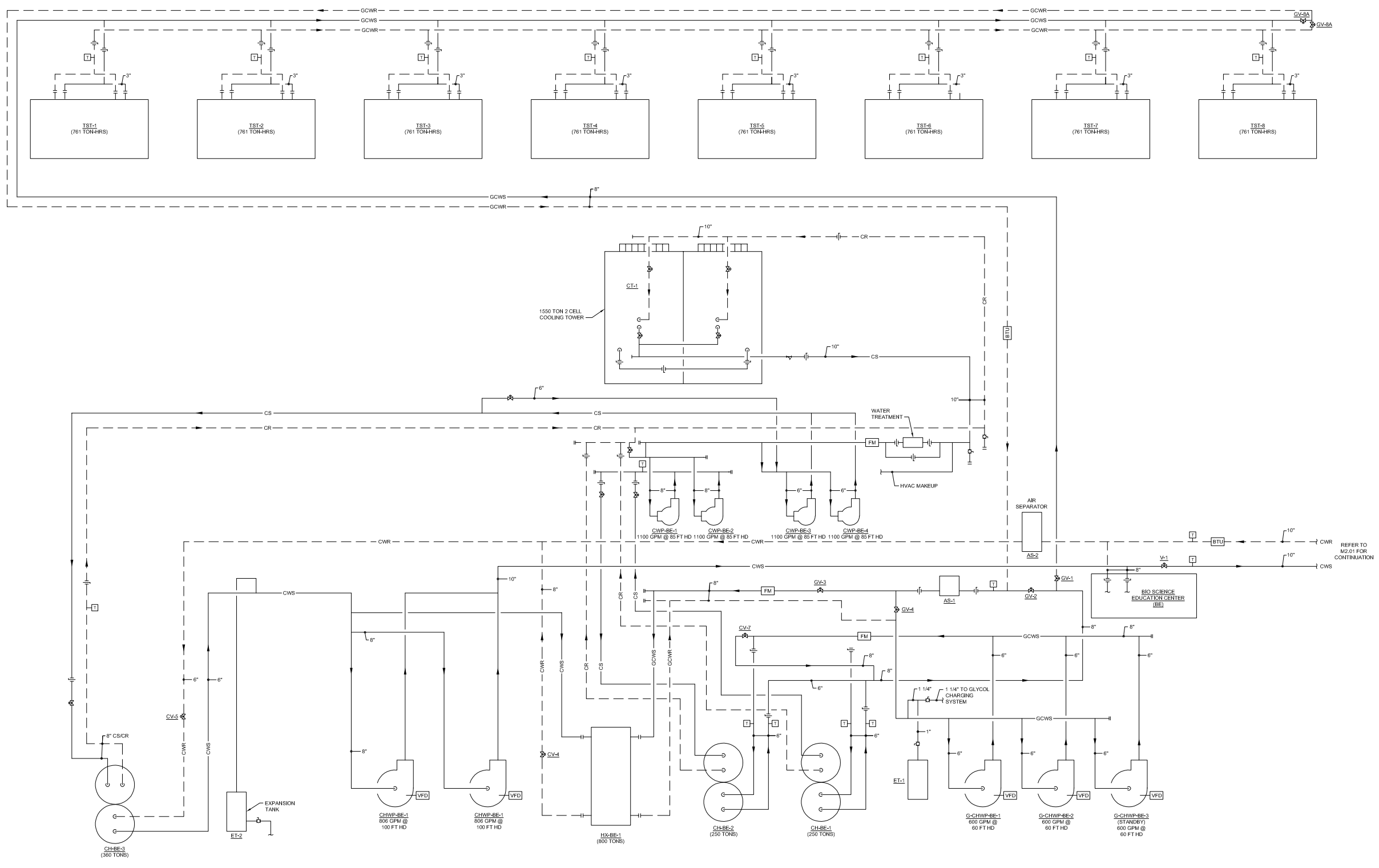

**SCHEMATIC - BIOSCIENCE BUILDING (BE)**  
**1 CHILLED WATER SYSTEM - EXISTING CONDITIONS**  
NOT TO SCALE

- DRAWING NOTES:**
1. TEMPERATURE TRANSMITTER TO BAS (TYPICAL).
  2. FLOW TRANSMITTER TO BAS (TYPICAL).

ARL:G:\19021.01\Drawings\Acad\MM\3.01 BE Chilled Water Schematic  
Plotted By: Tyler Koel | 6/10/2022 11:07 AM

PROJECT NAME:  
**Montgomery College**



**GERMANTOWN CAMPUS UTILITY MASTER PLAN**

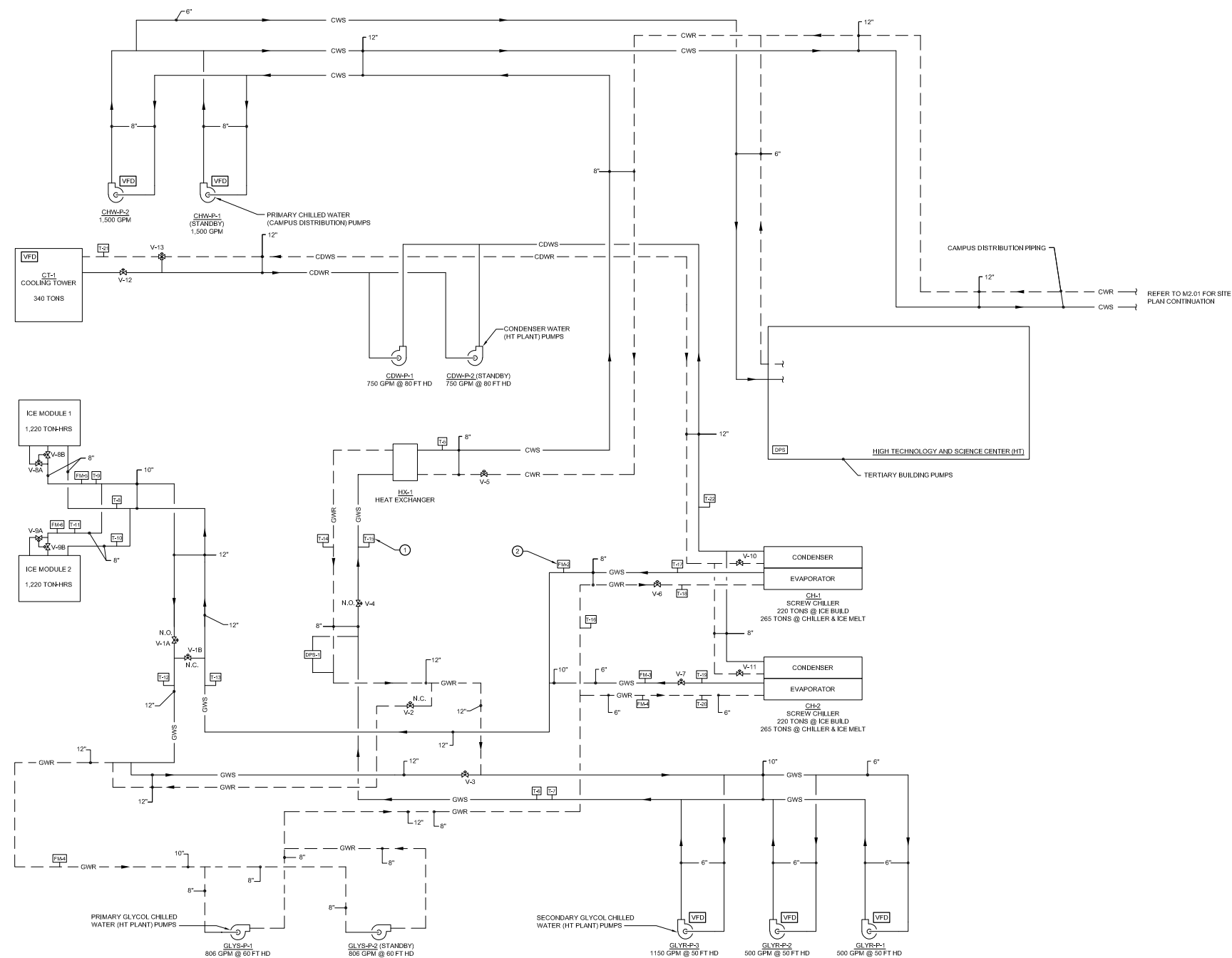

**SCHEMATIC - HIGH TECHNOLOGY BUILDING (HT) CHILLED WATER SYSTEM - EXISTING CONDITIONS**  
 1 NOT TO SCALE

- DRAWING NOTES:**
- ① TEMPERATURE TRANSMITTER TO BAS (TYPICAL).
  - ② FLOW TRANSMITTER TO BAS (TYPICAL).

SEAL:

ISSUED FOR:

DATE:	DESCRIPTION:
JUNE 2022	FINAL

PROJECT NO: BKM # 19021.01

SCALE: AS NOTED

DRAWN BY: CS

CHECKED BY: JMM

DATE: JUNE 2022

SHEET TITLE:  
**SCHEMATIC - (HT) CHILLED WATER SYSTEM EXISTING CONDITIONS**

DRAWING NO:  
**M3.02**

BKMF 19021.01



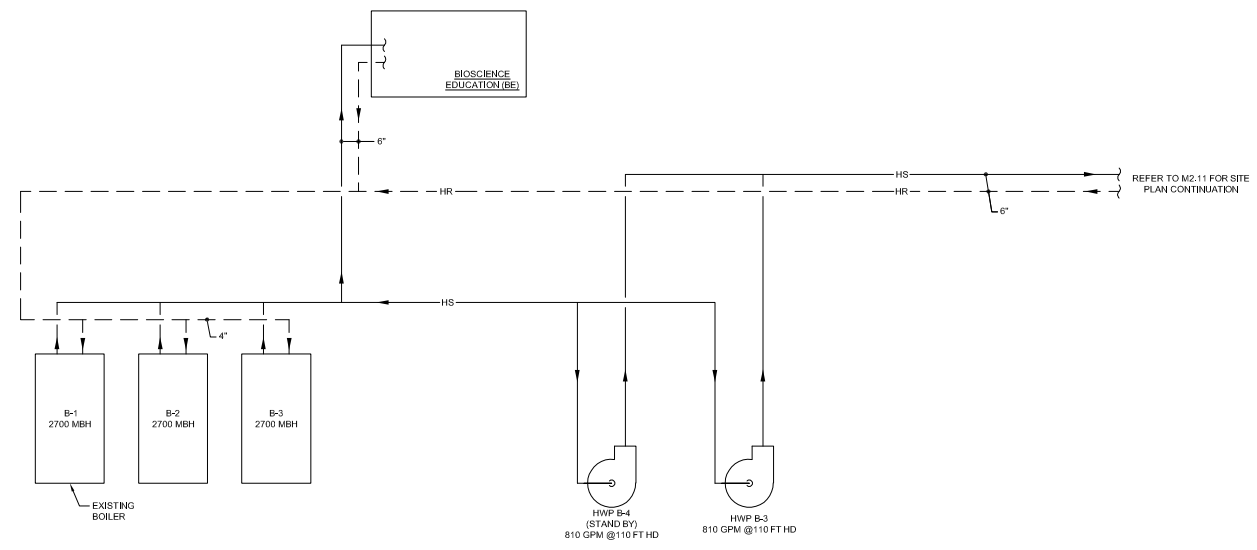

SEAL:

ISSUED FOR:

DATE:	DESCRIPTION:
JUNE 2022	FINAL

PROJECT NO: BKM # 19021.01

SCALE: AS NOTED

DRAWN BY: SY

CHECKED BY: JMM

DATE: JUNE 2022

SHEET TITLE:  
**SCHEMATIC - (BE)  
 HEATING WATER SYSTEM  
 EXISTING CONDITIONS**

DRAWING NO:  
**M3.11**  
 BKM# 19021.01

**1 SCHEMATIC - BIOSCIENCE BUILDING (BE) - HEATING WATER SYSTEM - EXISTING CONDITIONS**  
 NOT TO SCALE

PROJECT NAME:

**Montgomery College**



Central Administration  
 Office of Facilities  
 9221 Corporate Boulevard  
 Rockville, MD 20850  
 Telephone: 240-567-7363

**GERMANTOWN  
 CAMPUS  
 UTILITY MASTER  
 PLAN**

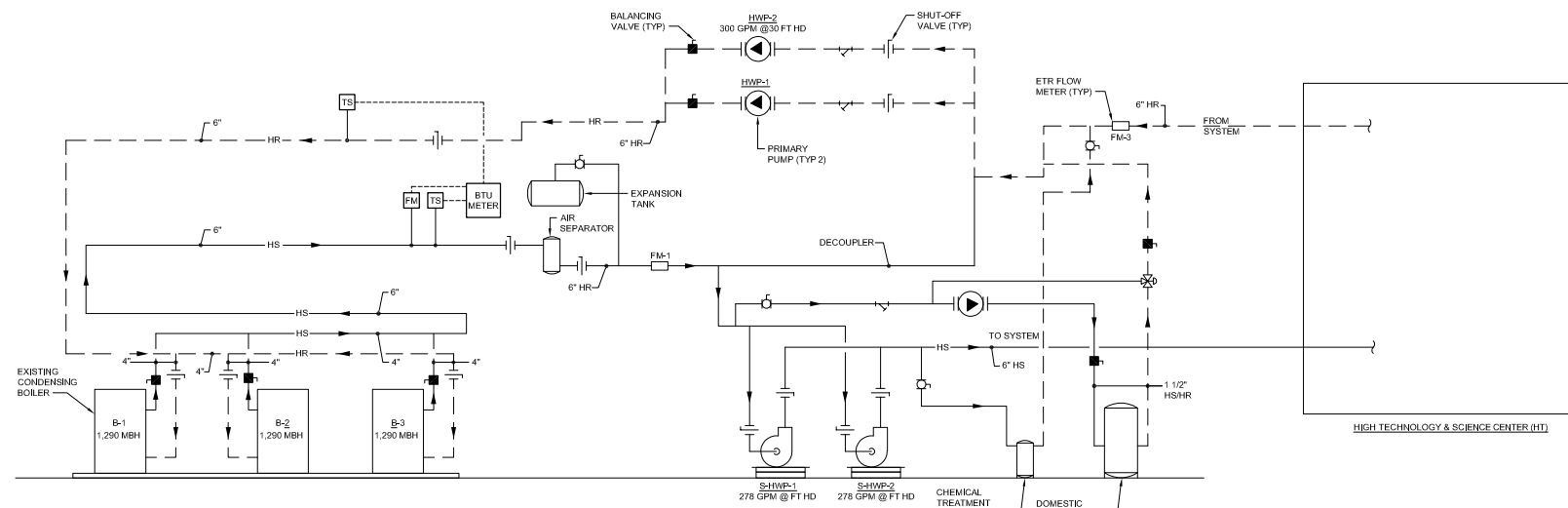

**1** SCHEMATIC - HIGH TECHNOLOGY BUILDING (HT) HEATING  
 WATER SYSTEM - EXISTING CONDITIONS  
 NOT TO SCALE

SEAL:

ISSUED FOR:

DATE:	DESCRIPTION:
JUNE 2022	FINAL

PROJECT NO: BKM # 19021.01

SCALE: AS NOTED

DRAWN BY: CS

CHECKED BY: JMM

DATE: JUNE 2022

SHEET TITLE:

**SCHEMATIC - (HT)  
 HEATING WATER SYSTEM  
 EXISTING CONDITIONS**

DRAWING NO:  
**M3.12HT**

BKMF 19021.01

PROJECT NAME:  
**Montgomery College**



**GERMANTOWN  
 CAMPUS  
 UTILITY MASTER  
 PLAN**

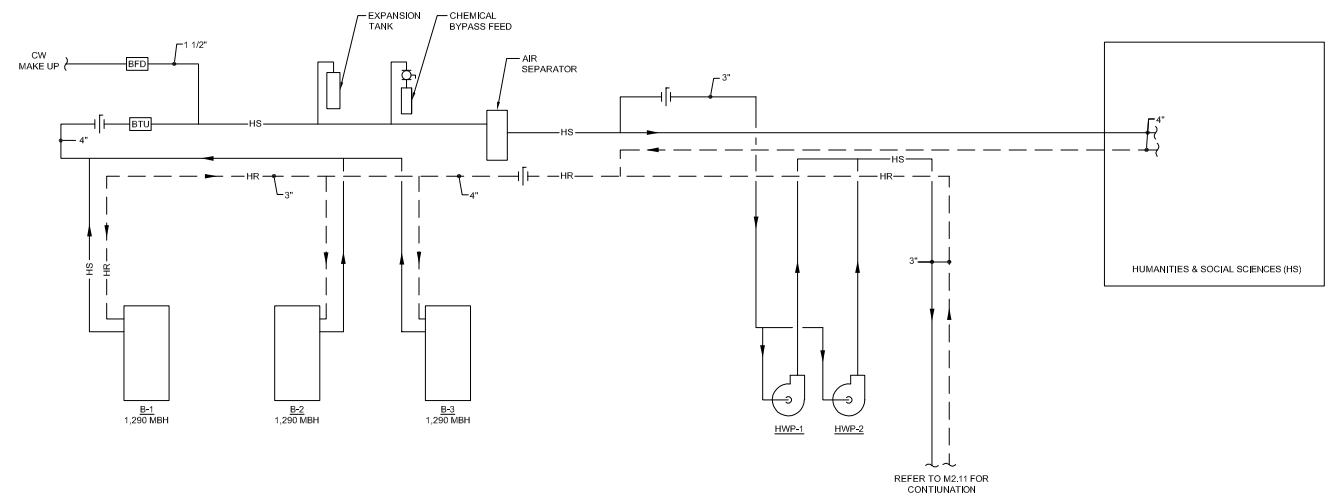

**SCHEMATIC - HUMANITIES BUILDING (HS)  
 HEATING WATER SYSTEM - EXISTING CONDITIONS**  
 1 NOT TO SCALE

SEAL:

ISSUED FOR:

DATE:	DESCRIPTION:
JUNE 2022	FINAL

PROJECT NO: BKM # 19021.01  
 SCALE: AS NOTED  
 DRAWN BY: CS  
 CHECKED BY: JMM  
 DATE: JUNE 2022

SHEET TITLE:  
**SCHEMATIC - HEATING  
 WATER SYSTEM SYSTEM  
 EXISTING CONDITIONS**

DRAWING NO:  
**M3.13**  
 BKM# 19021.01

PROJECT NAME:

**Montgomery College**



Central Administration  
Office of Facilities  
9221 Corporate Boulevard  
Rockville, MD 20850  
Telephone: 240-567-7363

**GERMANTOWN  
CAMPUS  
UTILITY MASTER  
PLAN**

SEAL:

ISSUED FOR:

DATE:	DESCRIPTION:
JUNE 2022	FINAL

PROJECT NO: BKM # 19021.01

SCALE: AS NOTED

DRAWN BY: BKM

CHECKED BY: BKM

DATE: JUNE 2022

SHEET TITLE:

**EQUIPMENT PLAN  
BIOSCIENCES CENTER (BE)  
EXISTING CONDITIONS**

DRAWING NO:

**M4.01**

BKMF 19021.01

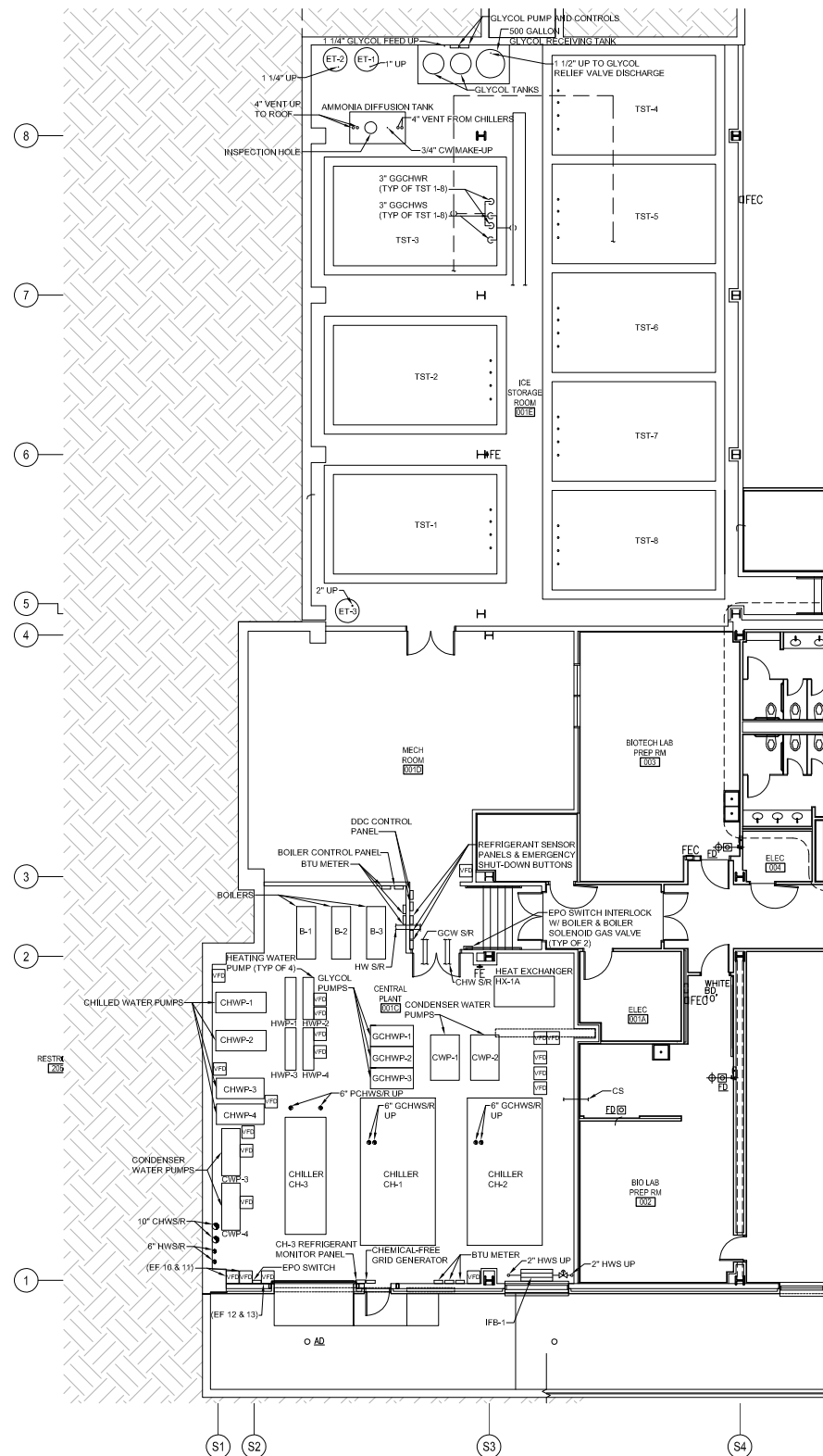

**1 EQUIPMENT PLAN - BIOSCIENCES CENTER (BE) - EXISTING CONDITIONS**  
SCALE: 1/8" = 1'-0"

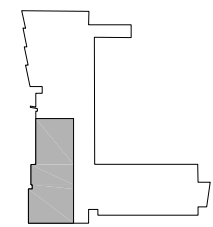

**KEY PLAN**  
NOT TO SCALE

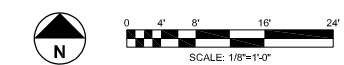

SEAL:

ISSUED FOR:

DATE:	DESCRIPTION:
JUNE 2022	FINAL

PROJECT NO: BKM # 19021.01  
 SCALE: AS NOTED  
 DRAWN BY: BKM  
 CHECKED BY: BKM  
 DATE: JUNE 2022

SHEET TITLE:  
**EQUIPMENT PLAN  
 HIGH TECHNOLOGY (HT)  
 EXISTING CONDITIONS**

DRAWING NO:  
**M4.02**  
 BKM# 19021.01

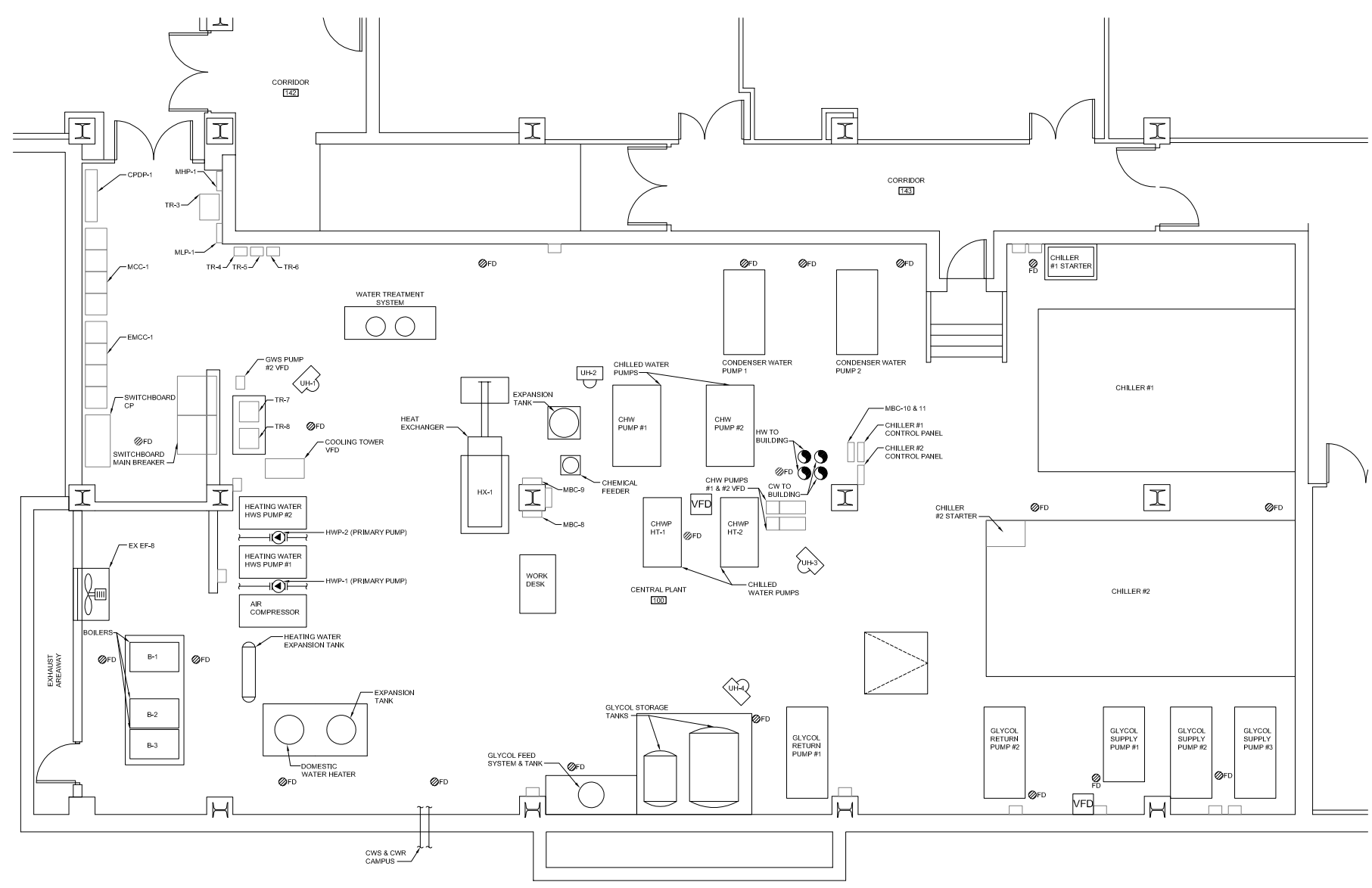

**1 EQUIPMENT PLAN - HIGH TECHNOLOGY (HT) - EXISTING CONDITIONS**  
 SCALE: 1/4" = 1'-0"

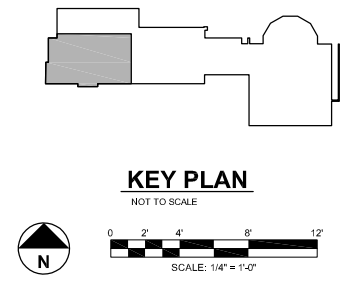

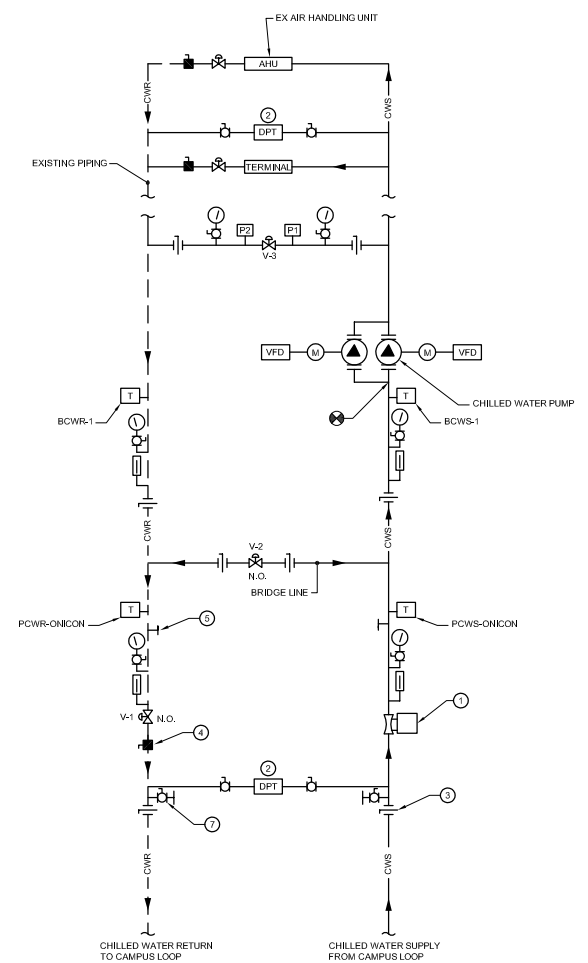

**TYPICAL CHILLED WATER PIPING - CENTRAL PLANT TO BUILDING CONNECTION DETAIL**  
 1  
 NO SCALE

- DRAWING NOTES:**
- ① ONICON SYSTEM 10 BTU METER.
  - ② DIFFERENTIAL PRESSURE TRANSMITTER.
  - ③ HIGH PERFORMANCE BUTTERFLY VALVE (TYPICAL FOR ALL BUTTERFLY VALVES).
  - ④ FLOW METER FITTING (VENTURI TYPE), TYPICAL.
  - ⑤ TEMPERATURE/PRESSURE TEST PORT.
  - ⑥ 2-WAY MODULATING DIFFERENTIAL PRESSURE CONTROL VALVE.
  - ⑦ LOW POINT DRAIN (TYPICAL).

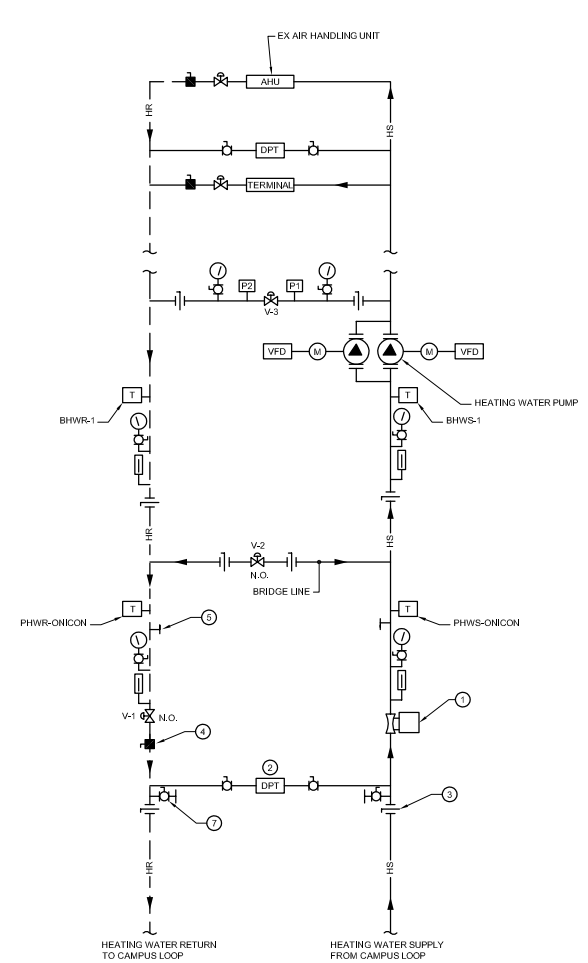

**TYPICAL HEATING WATER PIPING - CENTRAL PLANT TO BUILDING CONNECTION DETAIL**  
 1  
 NO SCALE

- DRAWING NOTES:**
- ① ONICON SYSTEM 10 BTU METER.
  - ② DIFFERENTIAL PRESSURE TRANSMITTER.
  - ③ HIGH PERFORMANCE BUTTERFLY VALVE (TYPICAL FOR ALL BUTTERFLY VALVES).
  - ④ FLOW METER FITTING (VENTURI TYPE), TYPICAL.
  - ⑤ TEMPERATURE/PRESSURE TEST PORT.
  - ⑥ 2-WAY MODULATING DIFFERENTIAL PRESSURE CONTROL VALVE.
  - ⑦ LOW POINT DRAIN (TYPICAL).

- GENERAL NOTES:**
1. BE AND HT INCLUDE CONNECTIONS FOR CHILLERS LOCATED IN THOSE BUILDINGS.
  2. SOME BUILDINGS INCLUDE CONNECTIONS DOMESTIC HOT WATER HEAT EXCHANGER AND POOL HEATING EQUIPMENT.

SEAL:

ISSUED FOR:

DATE:	DESCRIPTION:
JUNE 2022	FINAL

PROJECT NO: BKM # 19021.01  
 SCALE: AS NOTED  
 DRAWN BY: BKM  
 CHECKED BY: BKM  
 DATE: JUNE 2022

SHEET TITLE:  
**TYPICAL BUILDING CONNECTION DETAILS**

DRAWING NO:  
**M5.01**  
 BKM# 19021.01

# bkm

---

## Appendix 4 Electrical Systems

---

TABLE 4-1 - Electrical Loads - Existing Buildings

Year Built	Bldg Abbrev	Building Name	Bldg No	Area (GSF)	Pepco Account Number	Pepco Meter Number	Service Transformer (kVA) (1)	Service Voltage	Service Entrance Ampacity	Service Entrance Equipment Type	Service Entrance Equipment Manufacturer	Measured Peak Demand Load (kW) (2)	Calculated Peak Demand Load (kVA) (3)	Calculated VA per Square Foot (VA/SF)	Existing Building Generator	Notes
2014	BE	Bioscience Education Center	106	126,900	5501 5385 556	X8D351057345	TBS	480/277	4000A	Switchboard	Siemens SB3	1,296	1,800	14.18	200kW diesel generator, shared by BE & SA	
2012	CG	Child Care Center	107	5,535	5501 8733 273	X8D350573177	75	240/120	225A	Panelboard	General Electric A-Series	19	26	4.77	75kW diesel generator	
1978	HS	Humanities and Social Sciences	102	75,700	5501 9152 705	X8D351046266	1,500	480/277	1600A	Switchboard	Eaton Pow-R-Line C	402	558	7.38	130kW diesel generator	
1995	HT	High Technology and Science Center	104	75,542	5501 6468 914	KZD350747186	1,000	480/277	1600A	Switchboard	General Electric Spectra	152	211	2.79	400kW diesel generator, shared by HT and central plant	
1995	HT	High Technology and Science Center (Central Plant)	104	75,542	5501 4968 964	X8D351046725	1,000	480/277	2000A	Switchboard	Eaton Pow-R-Line C	447	621	8.22		
1983	PG	Physical Education Building	103	36,770	-	-	-	-	-	-	-	-	-	-		Building is fed from Humanities and Social Sciences.
1988	PK	Paul Peck Academic and Innovation Building	105	68,826	5501 7912 084	-	TBS	208Y/120	1600A	Switchboard	-	173	240	3.49	50kW diesel generator & 100kW diesel generator for house and tenant loads	
1978	SA	Science & Applied Studies	101	65,146	5001 7072 674	X8D350573707	1,000	480/277	2000A	Switchboard	Square D QED2	216	300	4.61		
1980	--	Grounds and Maintenance	-	6,055	5501 7037 544	-	150	208Y/120	-	-	-	-	-	-		Fed from pole mounted transformer
--	--	Greenhouse	-	-	-	-	-	-	-	-	-	-	-	-		Fed from HT.
--	--	Autoshed	-	-	-	-	-	-	-	-	-	-	-	-		

(1) Information obtained from previous master plan (2013).

(2) Maximum monthly peak demand value based on Pepco historical data (2017-2020).

(3) Measured peak demand kW divided by 0.9 (power factor conversion from kW to kVA) and multiplied by 1.25 (in accordance with NEC Article 220.87).

Estimated Total Campus Peak Demand Load (kVA):	3,757
--	-------



**TABLE 4-2 - Electrical Loads - Future Buildings**

Year Built	Bldg Abbrev	Building Name	Bldg No	Bldg Area (GSF)	Total Existing Load (kVA)	Total Removed Load (kVA)	Total Added Load (kVA)	Total Campus Load (kVA)	Notes
								3757	Estimated Total Campus Peak Demand Load from Table 1
2019	SA	Science and Applied Studies - Renovation	101	99,648	292	0	0	3757	
2025	HT	Central Plant (in High Technology) - New Building	104	0	-	0	0	3757	
2025	TBD	Student Services Center - New Building	TBD	95,000	-	0	1,425	5,182	
2027	HS	Humanities and Social Sciences - Renovation	102	75,700	558	0	0	5,182	Assume no change in electrical loads.
2027	SA	Science & Applied Studies - Demolition	101	37,200	292	292	0	4,890	
2027	SA	Science & Applied Studies - Addition	101	55,800	-	0	837	5,727	
2045	HS	Humanities and Social Sciences - Renovation	102	75,700	558	0	0	5,727	Assume no change in electrical loads.
2056	TBD	Parking Garage - New Building	TBD	324,000	-	0	1,620	7,347	
2059	TBD	Science/Math/Health Science - New Building	TBD	34,200	-	0	513	7,860	
2065	TBD	Arts and Communication - New Building	TBD	72,000	-	0	1,080	8,940	
2071	HT	High Technology - Renovation	104	75,542	211	0	0	8,940	Assume no change in electrical loads.
2077	PK	Paul Peck First Floor - Renovation	105	68,826	240	0	0	8,940	Assume no change in electrical loads.
2083	PG	Physical Education - Addition	103	36,500	-	0	548	9,487	
2083	PG	Physical Education - Renovation	103	36,770	-	0	0	9,487	Assume no change in electrical loads.

**TABLE 4-3 - Photovoltaic System - Near-Future Buildings**

Campus Area	Bldg Abbreviation	Bldg No	Surface Type	Existing Solar? (Y/N)	Potential PV Surface Area (ft <sup>2</sup> )	Estimated power from PV (in kW)*	Estimated Annual (kWh/Year)**	Estimated Annual Cost Savings from PV****	Notes
Humanities & Social Sciences Building	HS	102	Roof	N	20,500	205	388,680	\$42,716	Existing PV sytem is not operational and was not considered in this study. ***
Science & Applied Study Building	SA	101	Roof	N	13,100	131	248,376	\$27,297	***
Physical Education Building	PG	103	Roof	N	40,000	400	758,400	\$83,348	***
Paul Peck Academic & Innovation Building	PK	105	Roof	N	34,500	345	654,120	\$71,888	***
High Technology & Science Center	HT	104	Roof	N	0	0	0	\$0	***
Child Care Center	CG	107	Roof	N	0	0	0	\$0	***
Bioscience Education Center	BE	106	Roof	Y	15,400	154	291,984	\$32,089	***
Student Services Center - New Building	TBD	TBD	-	N	34,000	340	644,640	\$70,846	***
Parking Lots	-	-	Parking Lot Canopy	N	249,500	2,495	4,795,390	\$527,013	
Grounds	-	-	Ground	N	174,400	1,744	3,351,968	\$368,381	

\* Assumes 10W/SF

\*\* Estimated values obtained from PVWatts by National Renewable Energy Laboratory (NREL). Refer to drawing E1.04 for additional information.

\*\*\* PV located on roof will need either an existing structure capable of supporting solar panels or roof needs to be four years old or less.

\*\*\*\* Values obtained from multiplying Estimated Annaul kWh/Year times 10.99 cents/kWh. 10.99 cents rate obtained from electric.com. Actual annual cost savings from PV would be provided by project specific PV PPA service provider.

SEAL:

ISSUED FOR:

DATE:	DESCRIPTION:
JUNE 2022	FINAL

PROJECT NO: BKM # 19021.01

SCALE: AS NOTED

DRAWN BY: BKM

CHECKED BY: BKM

DATE: JUNE 2022

SHEET TITLE:  
**GERMANTOWN CAMPUS  
 SITE PLAN - POWER -  
 EXISTING CONDITIONS**

DRAWING NO:  
**E1.01**  
 BKM# 19021.01

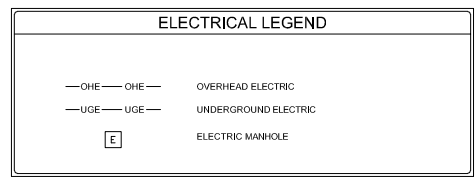
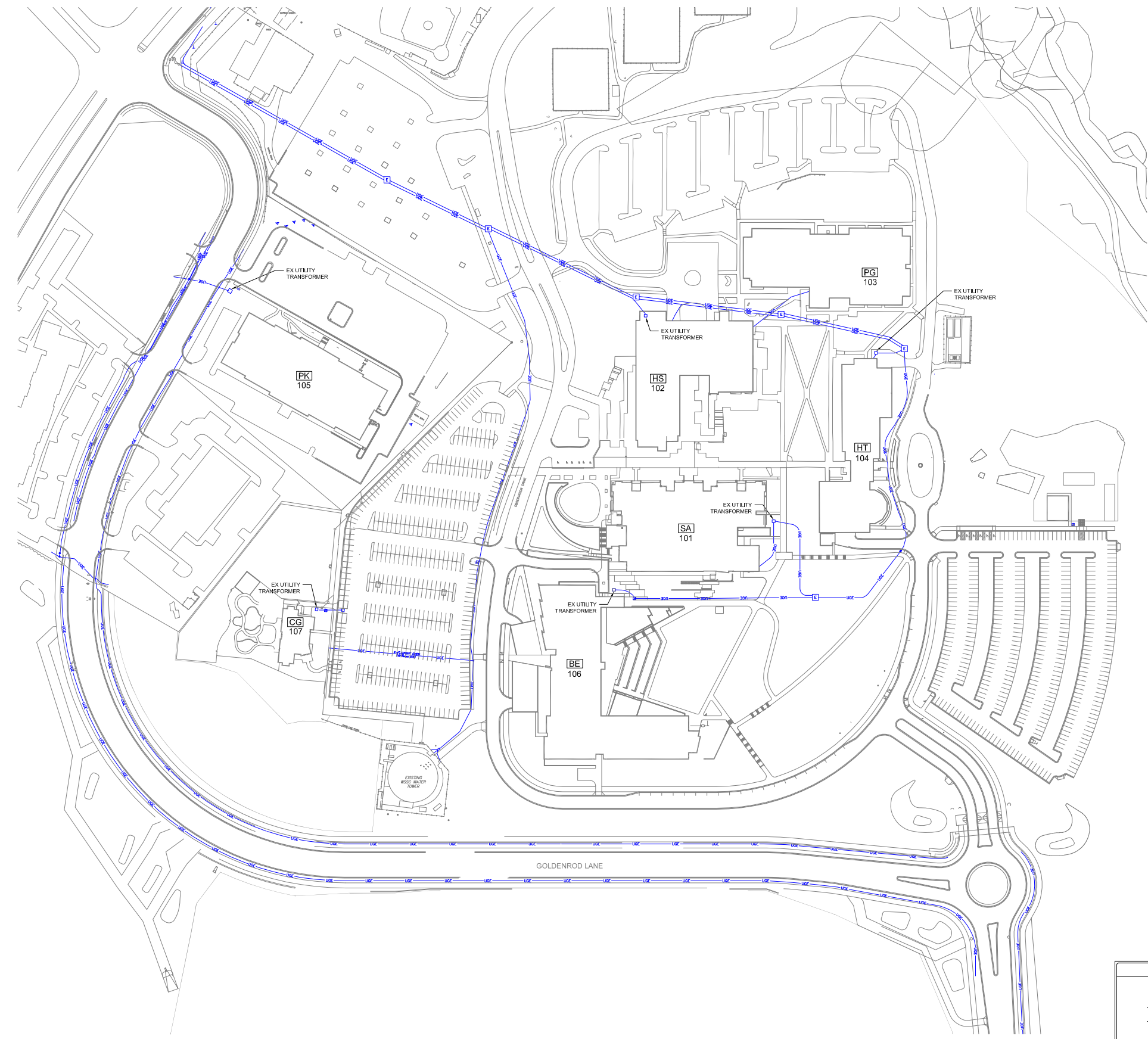

**1 SITE PLAN - POWER - EXISTING CONDITIONS**  
 SCALE: 1" = 80'-0"

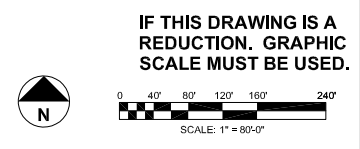

Plotted By: Tyler Kneel | 6/17/2022 12:56 PM  
 AR.L: G:\19021.01\Drawings\Acad\E1.01\_Site Plan Existing

PROJECT NAME:  
**Montgomery College**



**GERMANTOWN**  
**CAMPUS**  
**UTILITY MASTER**  
**PLAN**

SEAL:

ISSUED FOR:

DATE:	DESCRIPTION:
JUNE 2022	FINAL

PROJECT NO: BKM # 19021.01  
 SCALE: AS NOTED  
 DRAWN BY: BKM  
 CHECKED BY: BKM  
 DATE: JUNE 2022

SHEET TITLE:  
**GERMANTOWN CAMPUS**  
**SITE PLAN - POWER -**  
**NEAR-TERM FUTURE**

DRAWING NO:  
**E1.02**  
 BKM# 19021.01

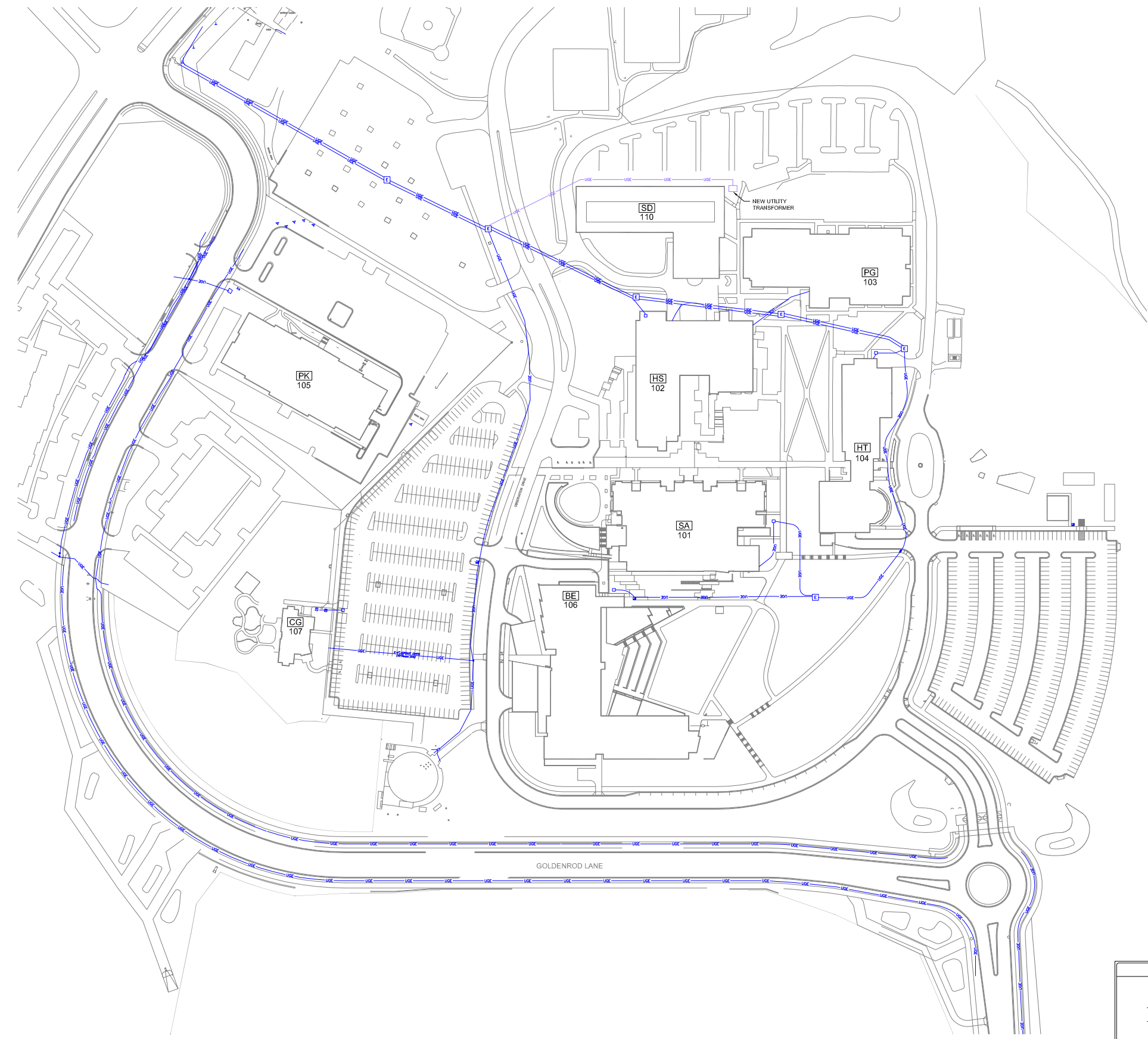

**ELECTRICAL LEGEND**

- OHE—OHE— OVERHEAD ELECTRIC
- UGE—UGE— UNDERGROUND ELECTRIC
- [E] ELECTRIC MANHOLE

**1 SITE PLAN - POWER - NEAR-TERM FUTURE CONDITIONS (2022-2034)**  
 SCALE: 1" = 80'-0"

IF THIS DRAWING IS A  
 REDUCTION, GRAPHIC  
 SCALE MUST BE USED.

0 40' 80' 120' 160' 240'  
 SCALE: 1" = 80'-0"

SEAL:

ISSUED FOR:

DATE:	DESCRIPTION:
JUNE 2022	FINAL

PROJECT NO: BKM # 19021.01

SCALE: AS NOTED

DRAWN BY: BKM

CHECKED BY: BKM

DATE: JUNE 2022

SHEET TITLE:  
**GERMANTOWN CAMPUS  
 SITE PLAN - POWER -  
 LONG-TERM FUTURE**

DRAWING NO:  
**E1.03**  
 BKM# 19021.01

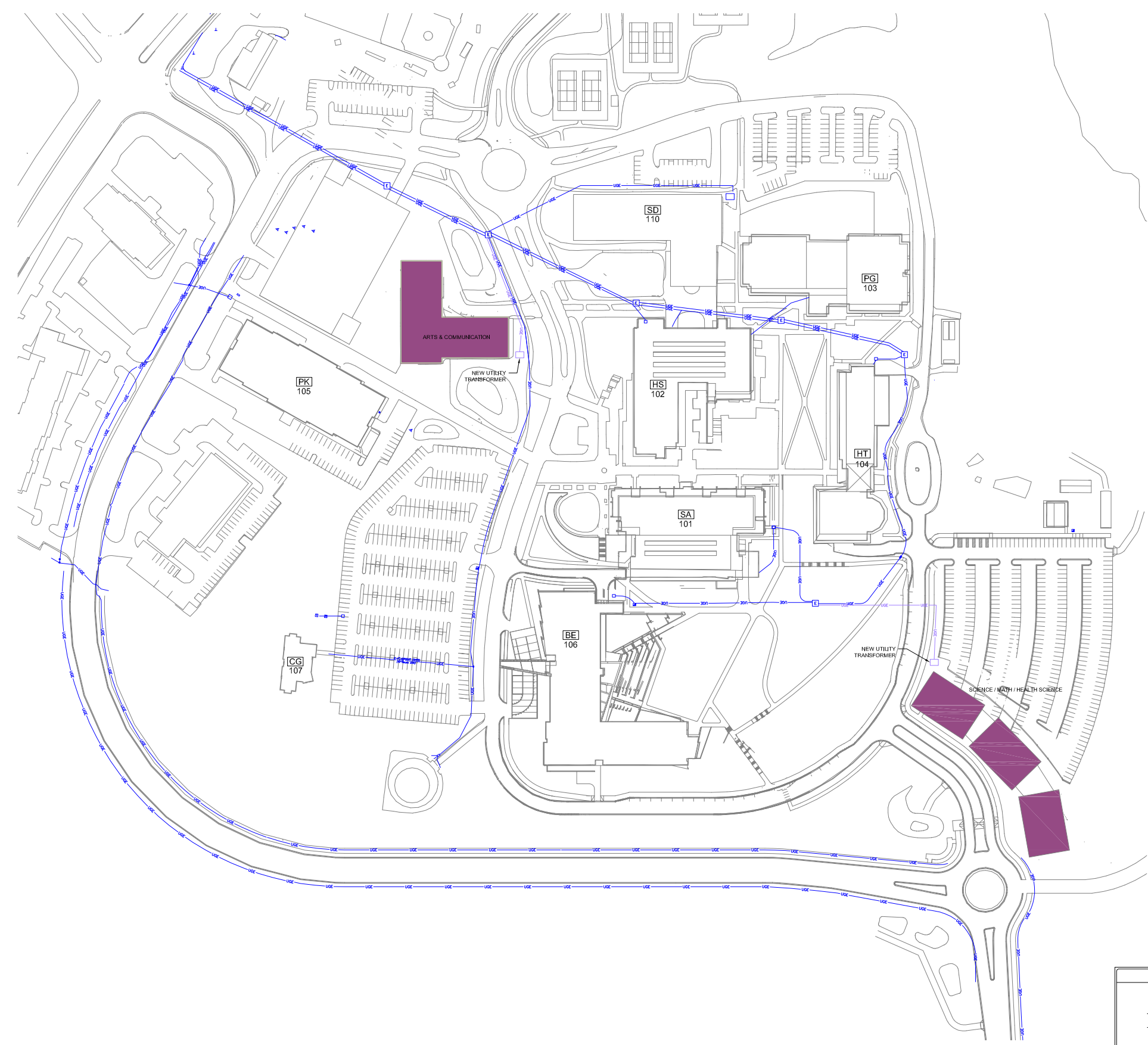

**ELECTRICAL LEGEND**

—OHE—OHE— OVERHEAD ELECTRIC

—UGE—UGE— UNDERGROUND ELECTRIC

[E] ELECTRIC MANHOLE

**1 SITE PLAN - POWER - LONG-TERM FUTURE CONDITIONS (2035-BEYOND)**  
 SCALE: 1" = 80'-0"

IF THIS DRAWING IS A  
 REDUCTION, GRAPHIC  
 SCALE MUST BE USED.

N

0 40' 80' 120' 160' 240'

SCALE: 1" = 80'-0"

PROJECT NAME:  
**Montgomery College**



**GERMANTOWN**  
**CAMPUS**  
**UTILITY MASTER**  
**PLAN**

SEAL:

ISSUED FOR:

DATE:	DESCRIPTION:
JUNE 2022	FINAL

PROJECT NO: BKM # 19021.01  
 SCALE: AS NOTED  
 DRAWN BY: BKM  
 CHECKED BY: BKM  
 DATE: JUNE 2022

SHEET TITLE:  
**SITE PLAN - POTENTIAL**  
**PHOTOVOLTAIC LOCATIONS**

DRAWING NO:  
**E1.04**  
 BKM# 19021.01

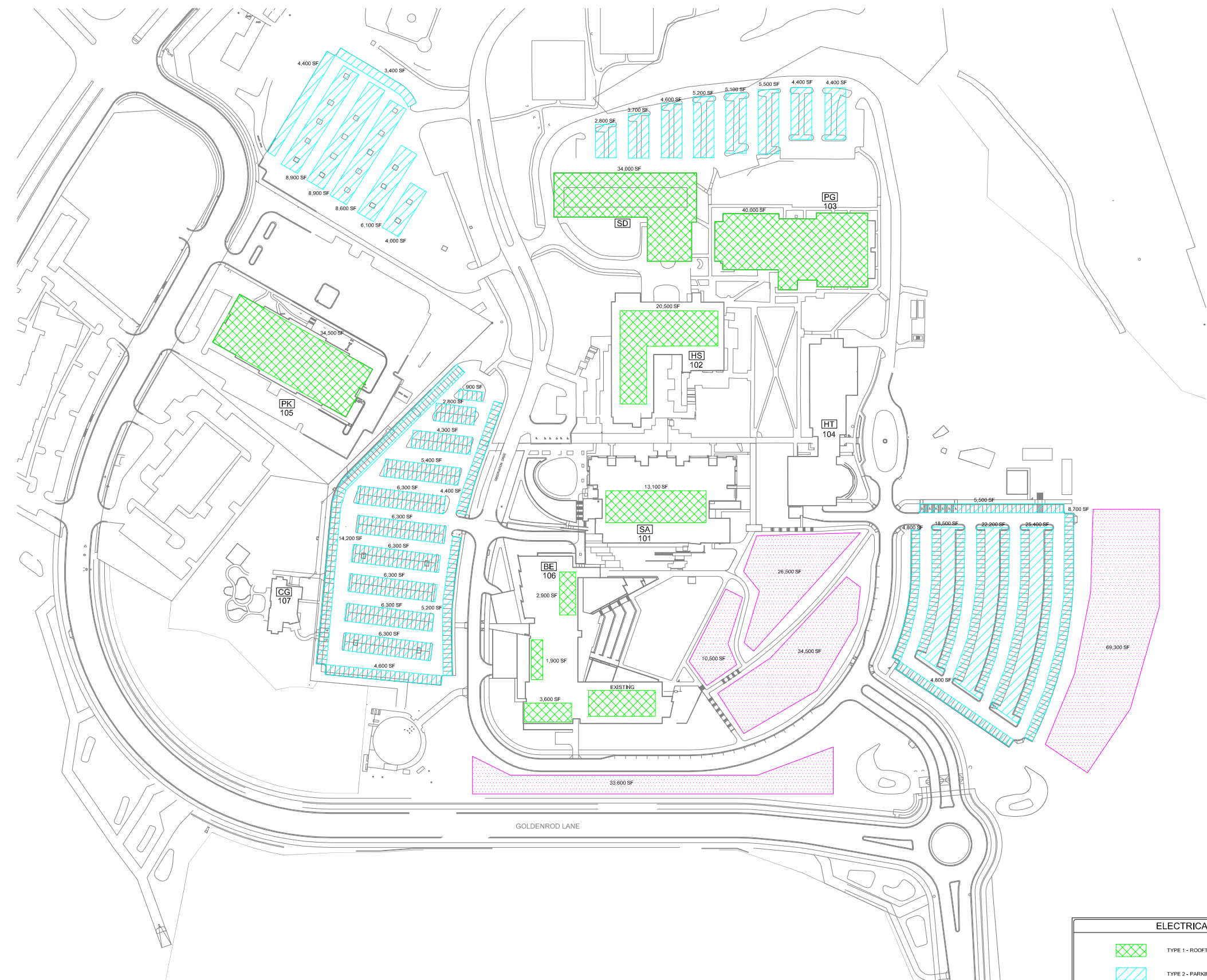

**ELECTRICAL LEGEND**

- TYPE 1 - ROOFTOP
- TYPE 2 - PARKING LOT (CANOPY MOUNTED)
- TYPE 3 - GROUND

**1 SITE PLAN - POTENTIAL PHOTOVOLTAIC LOCATIONS**  
 SCALE: 1" = 80'-0"

**IF THIS DRAWING IS A**  
**REDUCTION, GRAPHIC**  
**SCALE MUST BE USED.**

SCALE: 1" = 80'-0"

Plotted By: Tyler Koell | 6/17/2022 12:42 PM  
 ARL: G:\19021.01\Drawings\Acad\E1.04\_Site Plan.rvt

**GENERAL NOTES:**  
 1. PROPOSED UNDERGROUND CONDUIT ROUTING, MANHOLE AND SPICE BOX LOCATIONS ARE PRELIMINARY AND SHALL BE USED FOR COST ESTIMATING PURPOSES ONLY.

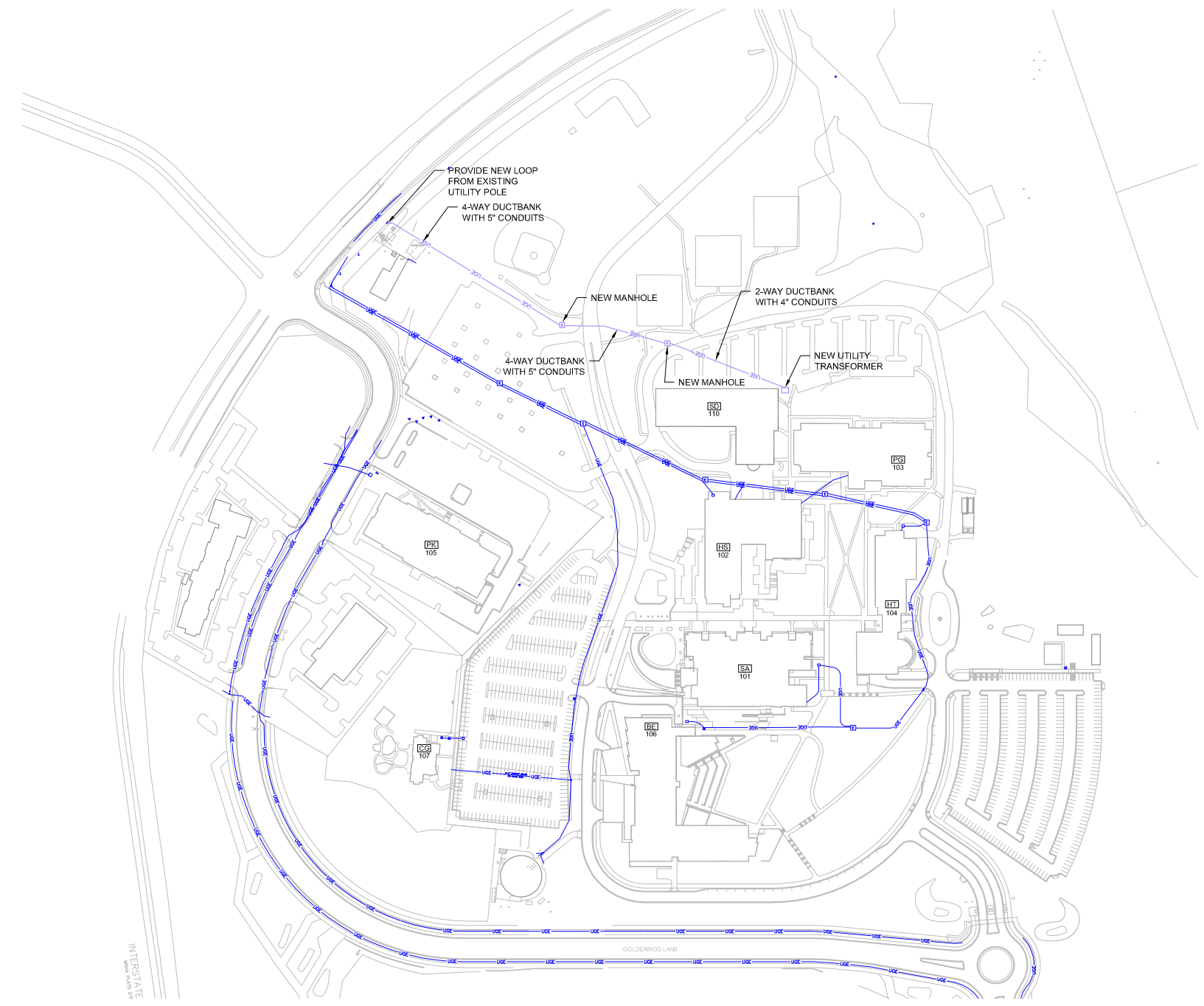

**1 SITE PLAN - POWER - NEAR-TERM FUTURE - NEW NORTH LOOP**  
 SCALE: 1" = 120'-0"

ELECTRICAL LEGEND		
—OHE—OHE—	OVERHEAD ELECTRIC	
—UGE—UGE—	UNDERGROUND ELECTRIC	
[E]	ELECTRIC MANHOLE	

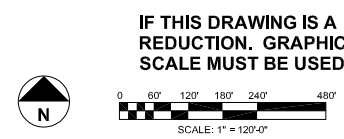

SEAL:

ISSUED FOR:	
DATE:	DESCRIPTION:
JUNE 2022	FINAL

PROJECT NO: BKM # 19021.01

SCALE: AS NOTED

DRAWN BY: BKM

CHECKED BY: BKM

DATE: JUNE 2022

SHEET TITLE:  
**SITE PLAN - POWER - NEAR-TERM FUTURE - NEW NORTH LOOP**

DRAWING NO:  
**E1.05**

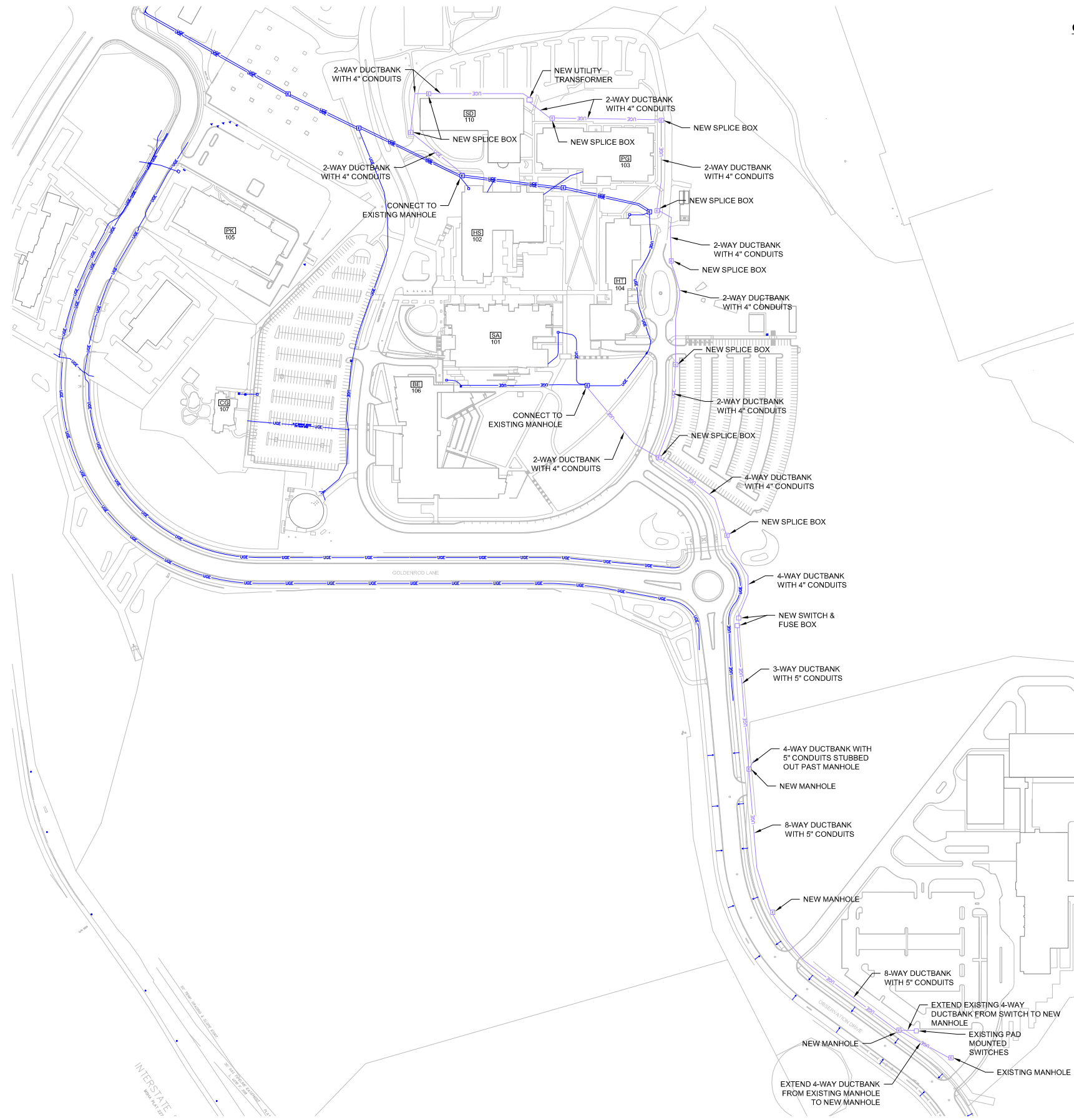

**GENERAL NOTES:**  
 1. PROPOSED UNDERGROUND CONDUIT ROUTING, MANHOLE AND SPLICE BOX LOCATIONS ARE PRELIMINARY AND SHALL BE USED FOR COST ESTIMATING PURPOSES ONLY.

**bkm**  
 Burdette, Koehler, Murphy & Associates, Inc.  
 Mechanical/Electrical Engineers  
 6301 Bellvue Suburban Road, Baltimore, Maryland 21209  
 P. 410.323.0000 | www.bkma.com

PROJECT NAME:  
**Montgomery College**  
**MC**  
**MONTGOMERY COLLEGE**  
 Central Administration  
 Office of Facilities  
 9221 Corporate Boulevard  
 Rockville, MD 20850  
 Telephone: 240-567-7363  
**GERMANTOWN CAMPUS**  
**UTILITY MASTER PLAN**

SEAL:

ISSUED FOR:

DATE:	DESCRIPTION:
JUNE 2022	FINAL

PROJECT NO: BKM # 19021.01  
 SCALE: AS NOTED  
 DRAWN BY: BKM  
 CHECKED BY: BKM  
 DATE: JUNE 2022  
 SHEET TITLE:

**SITE PLAN - POWER - NEAR-TERM FUTURE - NEW SOUTH LOOP**

DRAWING NO:  
**E1.06**  
 BKM# 19021.01

**1 SITE PLAN - POWER - NEAR-TERM FUTURE - NEW SOUTH LOOP**  
 SCALE: 1" = 120'-0"

**ELECTRICAL LEGEND**

—OHE—OHE—	OVERHEAD ELECTRIC
—UGE—UGE—	UNDERGROUND ELECTRIC
[E]	ELECTRIC MANHOLE

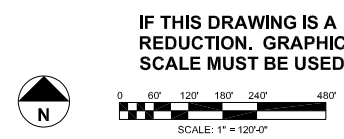

Printed By: Tyler Kneel | 6/17/2022 12:42 PM  
 AR.L:G:\19021.01\Drawings\Acad\E1.06\_Site Plan Near Future - South Loop



SEAL:

ISSUED FOR:

DATE:	DESCRIPTION:
JUNE 2022	FINAL

PROJECT NO: BKM # 19021.01  
 SCALE: AS NOTED  
 DRAWN BY: BKM  
 CHECKED BY: BKM  
 DATE: JUNE 2022

SHEET TITLE:  
**SINGLE-LINE DIAGRAM - POWER - EXISTING CONDITIONS**

DRAWING NO:  
**E2.01**  
 BKM# 19021.01

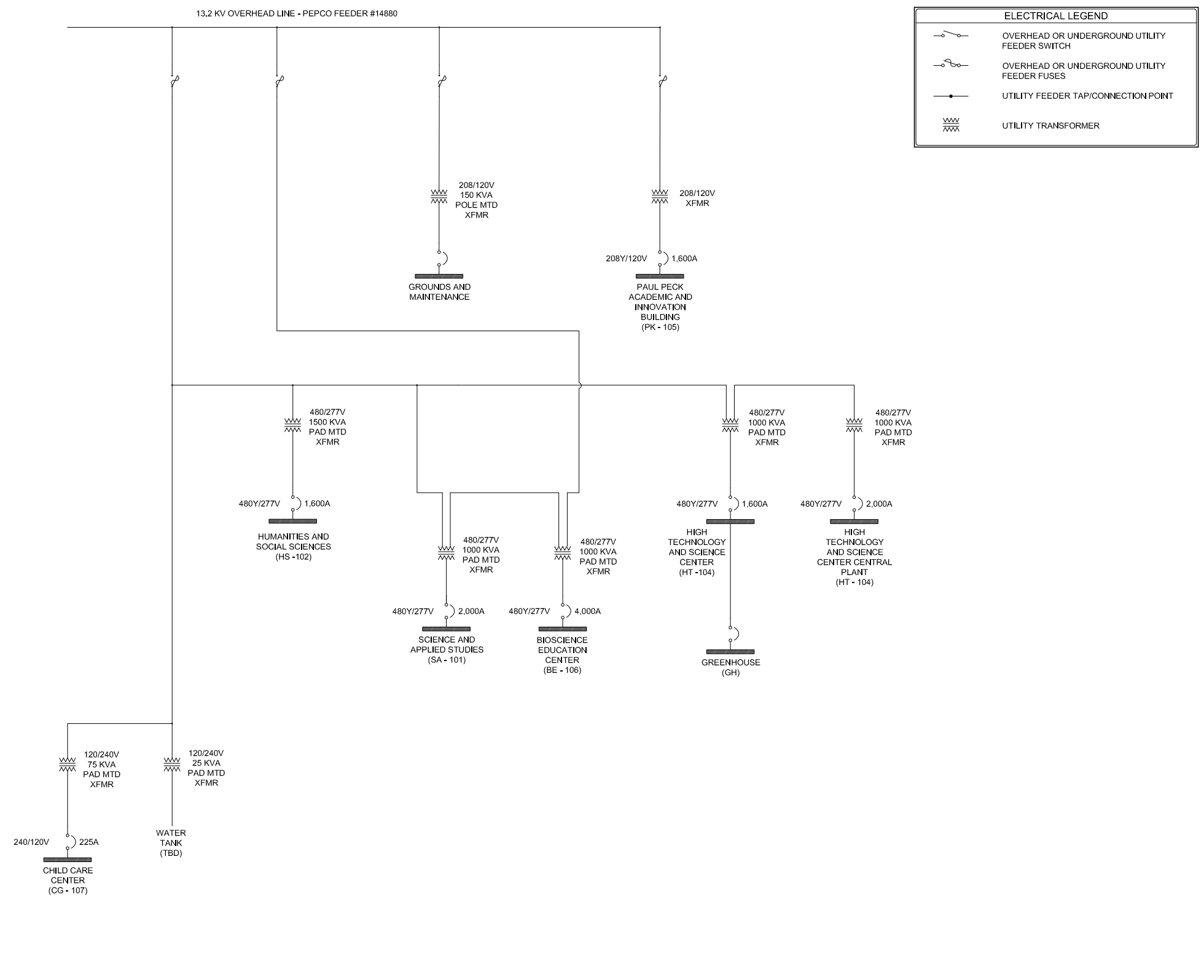

**1 SINGLE-LINE DIAGRAM - POWER - EXISTING CONDITIONS**  
 SCALE: NONE

Pinned By: Tyler Koel | 6/17/2022 12:38 PM  
 ARL: G:\19021.01\Drawings\Acad\E19201\_SingleLine.dwg

PROJECT NAME:  
**Montgomery College**



**GERMANTOWN  
 CAMPUS  
 UTILITY MASTER  
 PLAN**

SEAL:

ISSUED FOR:

DATE:	DESCRIPTION:
JUNE 2022	FINAL

PROJECT NO: BKM # 19021.01

SCALE: AS NOTED

DRAWN BY: BKM

CHECKED BY: BKM

DATE: JUNE 2022

SHEET TITLE:

**SINGLE-LINE DIAGRAM -  
 POWER - LONG-TERM  
 FUTURE CONDITIONS**

DRAWING NO:  
**E2.02**  
 BKM# 19021.01

**ELECTRICAL LEGEND**

- OVERHEAD OR UNDERGROUND UTILITY FEEDER SWITCH
- OVERHEAD OR UNDERGROUND UTILITY FEEDER FUSES
- UTILITY FEEDER TAP/CONNECTION POINT
- UTILITY TRANSFORMER

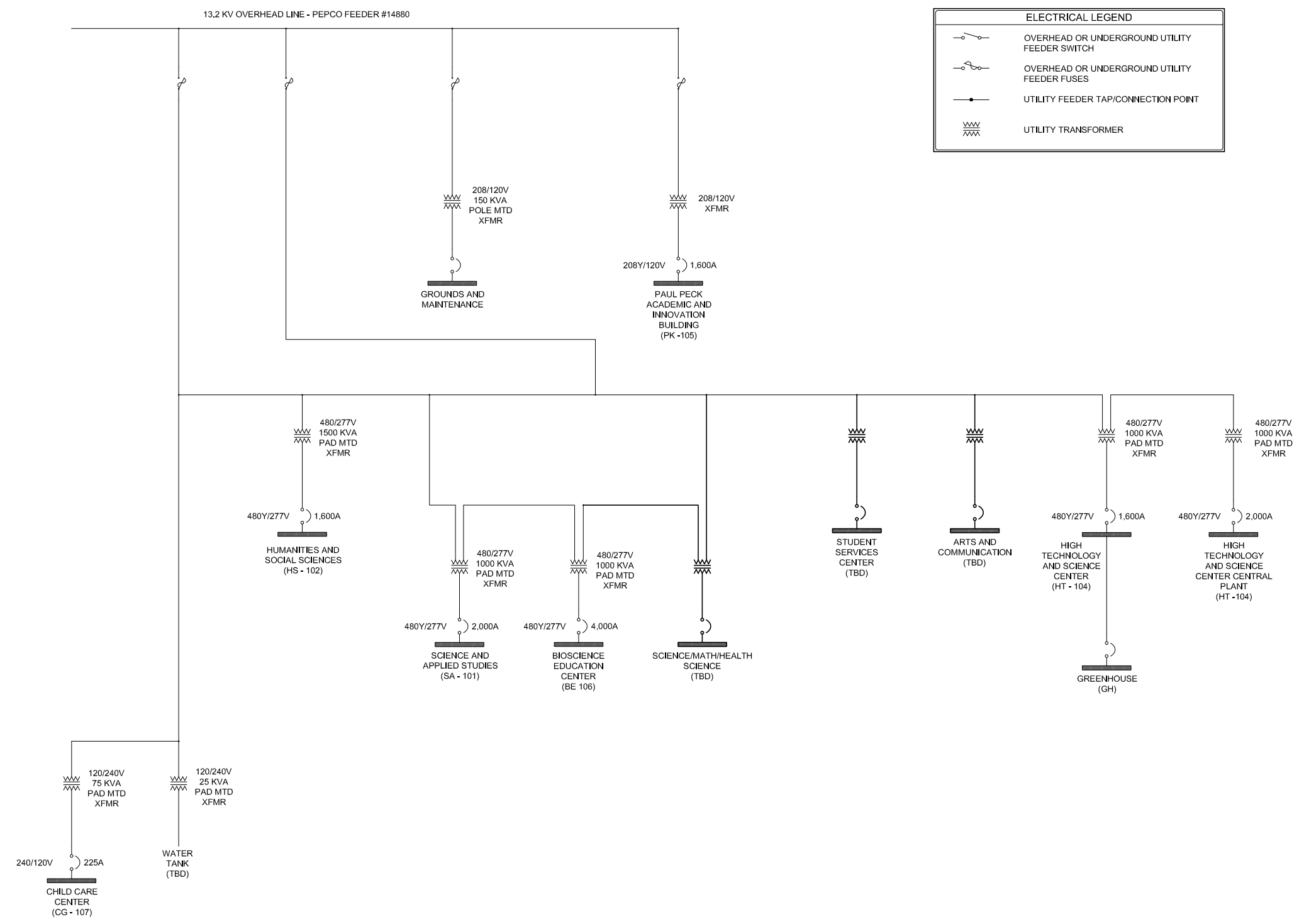

**1 SINGLE-LINE DIAGRAM - POWER -  
 LONG-TERM FUTURE CONDITIONS**  
 SCALE: NONE

P:\bkm\19021.01\Drawings\Acad\E1E202 Single-Line Future  
 Plotted By: Tyler Koell | 6/17/2022 12:38 PM

bkm

---

Appendix 5  
MC Provided Information

---

Monthly Demand by Year

Executive Summary (kW)

Monthly Demand by Year

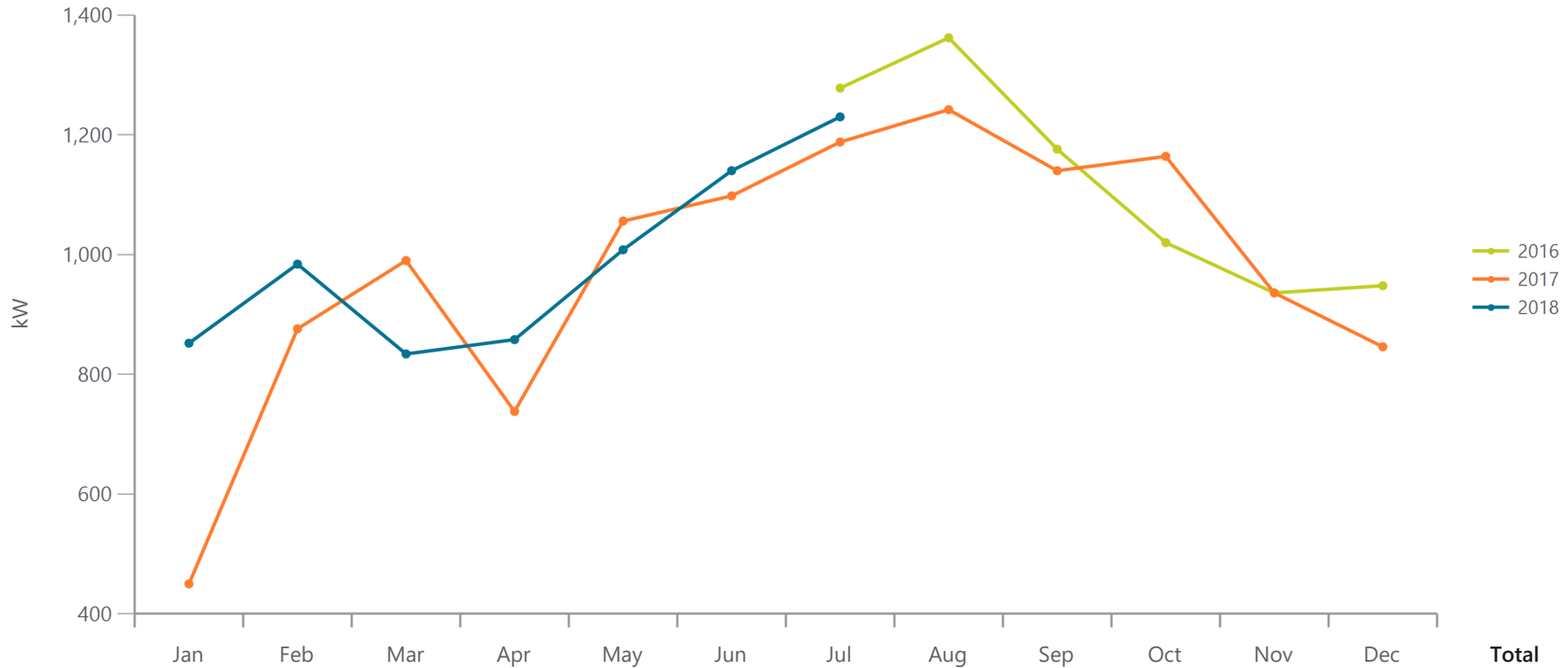

Year	Jan	Feb	Mar	Apr	May	Jun	Jul	Aug	Sep	Oct	Nov	Dec	Total
2016							1,278	1,362	1,176	1,020	936	948	6,720
2017	450	876	990	738	1,056	1,098	1,188	1,242	1,140	1,164	936	846	11,724
2018	852	984	834	858	1,008	1,140	1,230						6,906

This account serves electricity to the building and chill water to this building.

Monthly Demand by Year

Executive Summary (kW)

Monthly Demand by Year

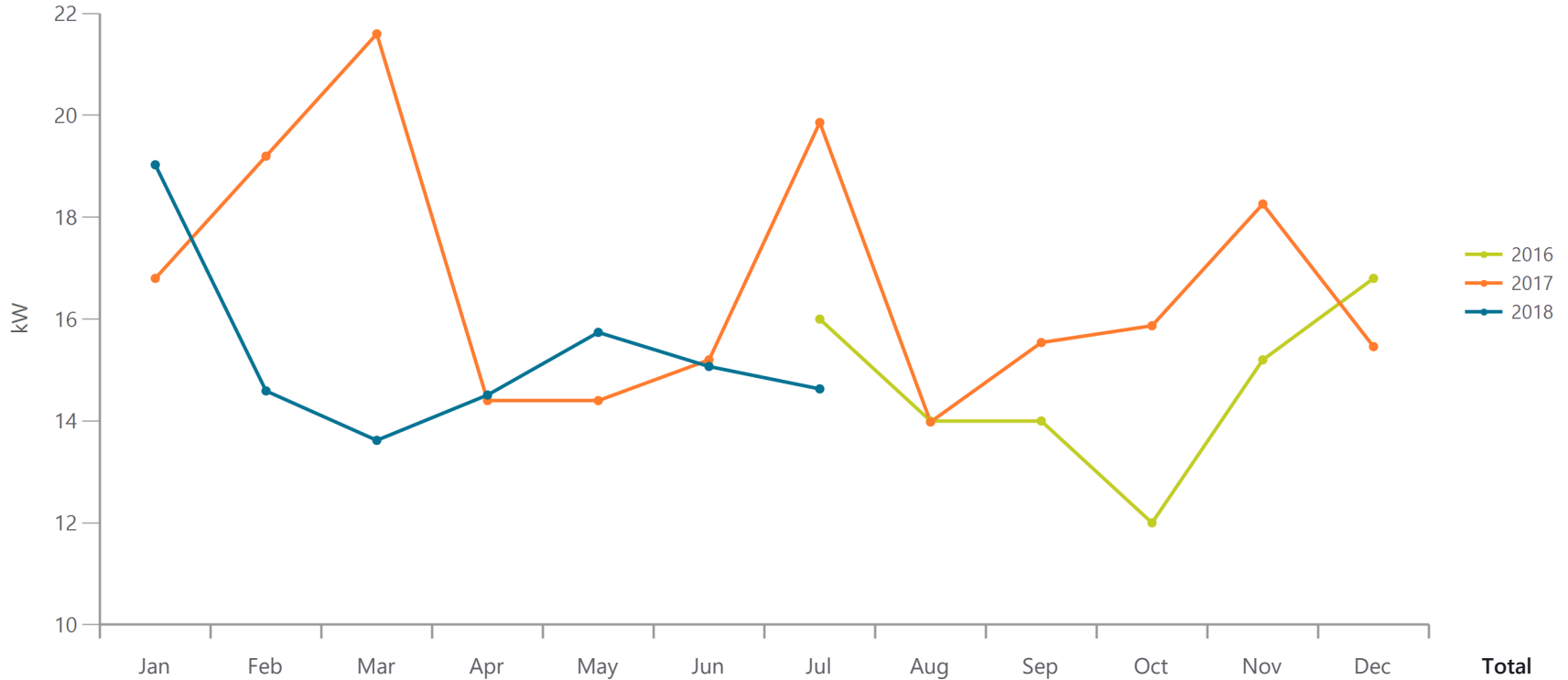

	Jan	Feb	Mar	Apr	May	Jun	Jul	Aug	Sep	Oct	Nov	Dec	Total
2016							16	14	14	12	15	17	88
2017	17	19	22	14	14	15	20	14	16	16	18	15	201
2018	19	15	14	15	16	15	15						107

Building is currently unoccupied.

Monthly Demand by Year

Executive Summary (kW)

Monthly Demand by Year

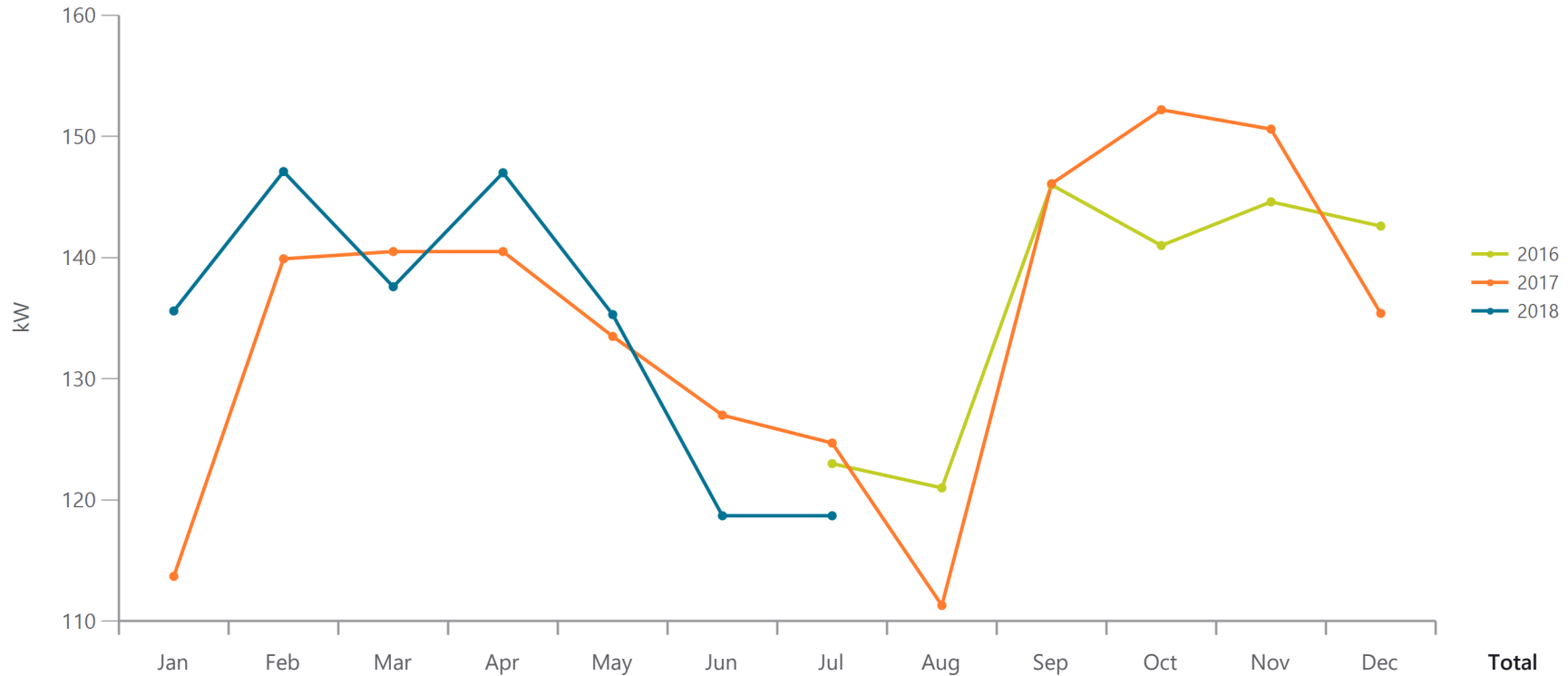

Year	Jan	Feb	Mar	Apr	May	Jun	Jul	Aug	Sep	Oct	Nov	Dec	Total
2016	-	-	-	-	-	-	123	121	146	141	145	143	818
2017	114	140	141	141	134	127	125	111	146	152	151	135	1,615
2018	136	147	138	147	135	119	119	-	-	-	-	-	940

This is the second HT (HT-Inst) not Plant account serving electricity to the building.

Monthly Demand by Year

Executive Summary (kW)

Monthly Demand by Year

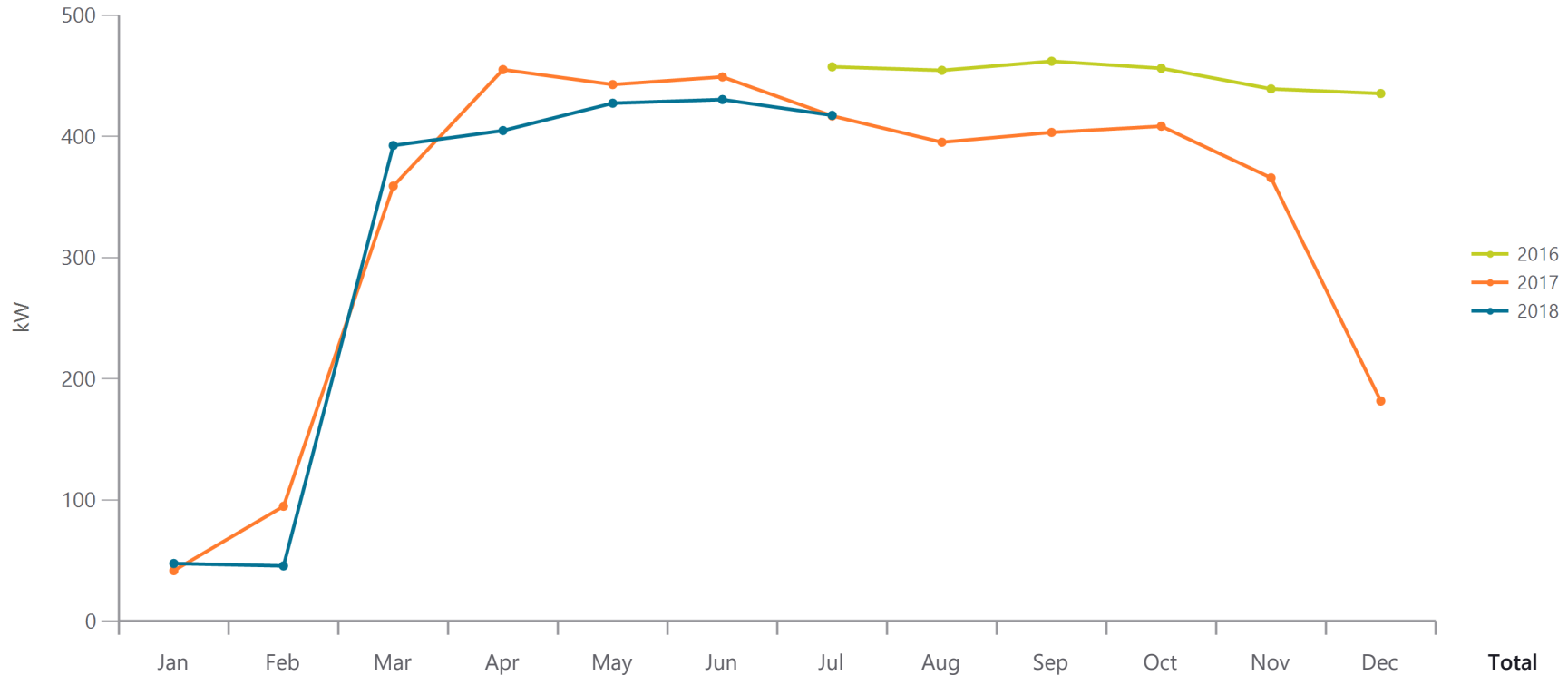





Year	Jan	Feb	Mar	Apr	May	Jun	Jul	Aug	Sep	Oct	Nov	Dec	Total
2016							457	455	462	456	439	435	2,705
2017	42	95	359	455	443	449	417	395	403	408	366	182	4,014
2018	48	46	393	405	427	430	417						2,166

Monthly Demand by Year

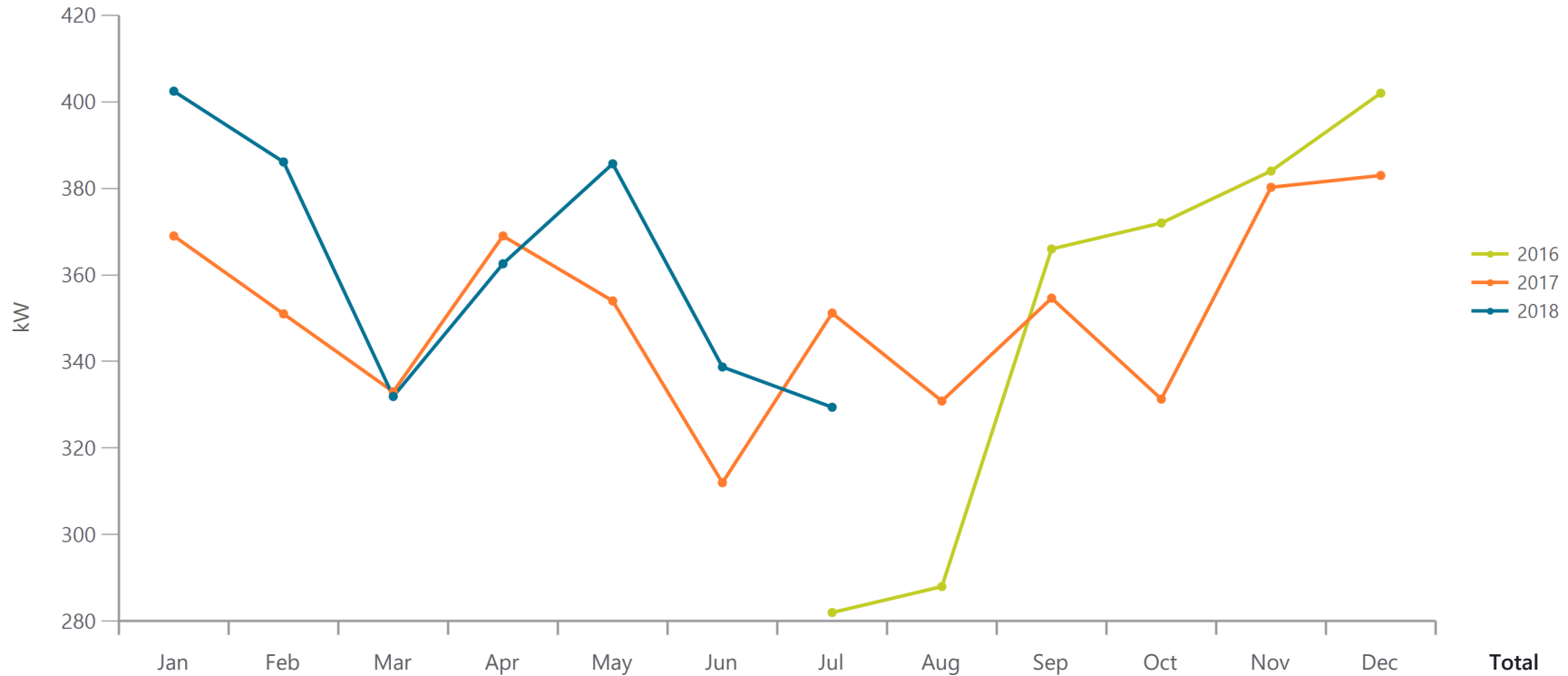
Executive Summary (kW)

Monthly Demand by Year



	2016						282	288	366	372	384	402	2,094	
	2017	369	351	333	369	354	312	351	331	355	331	380	383	4,219
	2018	402	386	332	363	386	339	329					2,537	

This meter is located in HS, but serves electricity to both buildings.





Monthly Demand by Year

Executive Summary (kW)

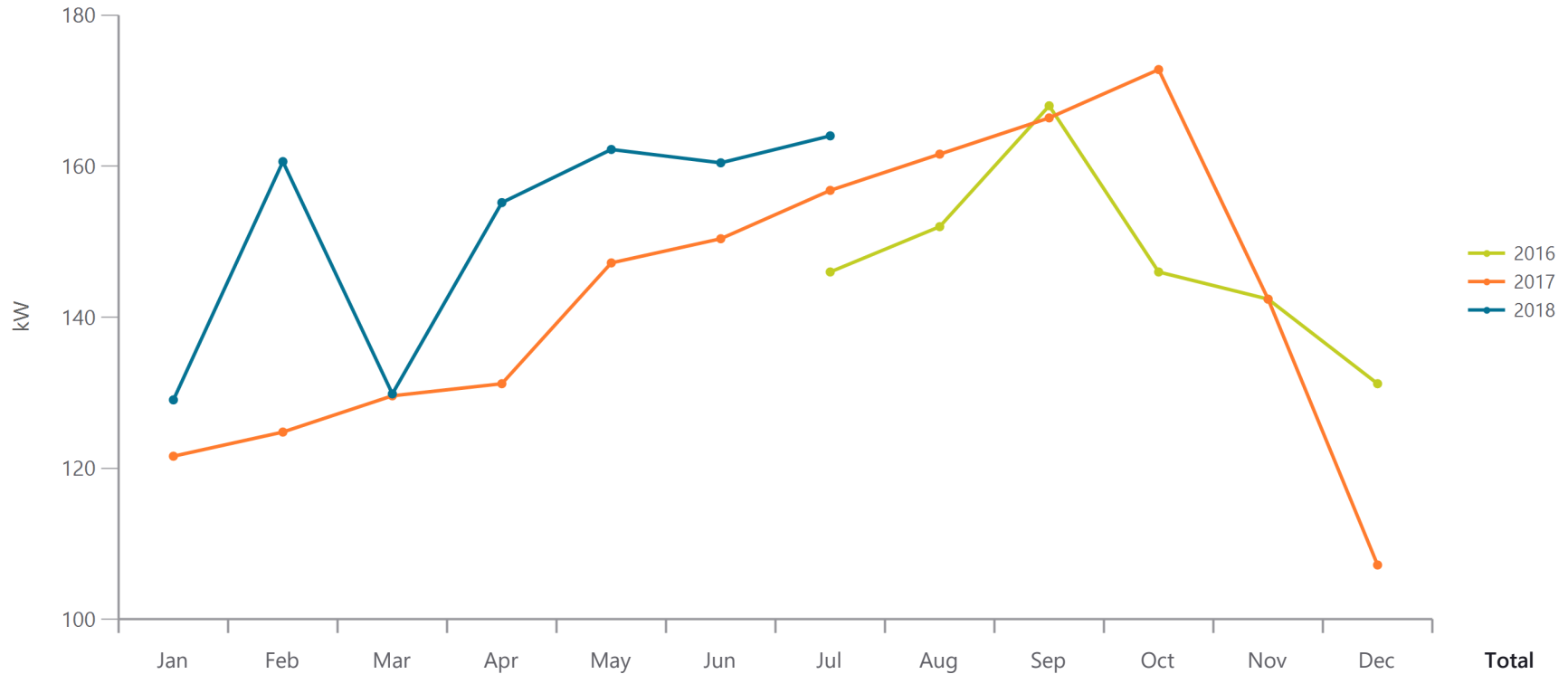
Monthly Demand by Year



	2016						146	152	168	146	142	131	886	
	2017	122	125	130	131	147	150	157	162	166	173	142	107	1,712
	2018	129	161	130	155	162	160	164					1,061	



This is demand data for only the first floor of the building. The second floor are labs leased out to small businesses. The College only receives kWh use for the 2nd floor.

Monthly Demand by Year

Executive Summary (kW)

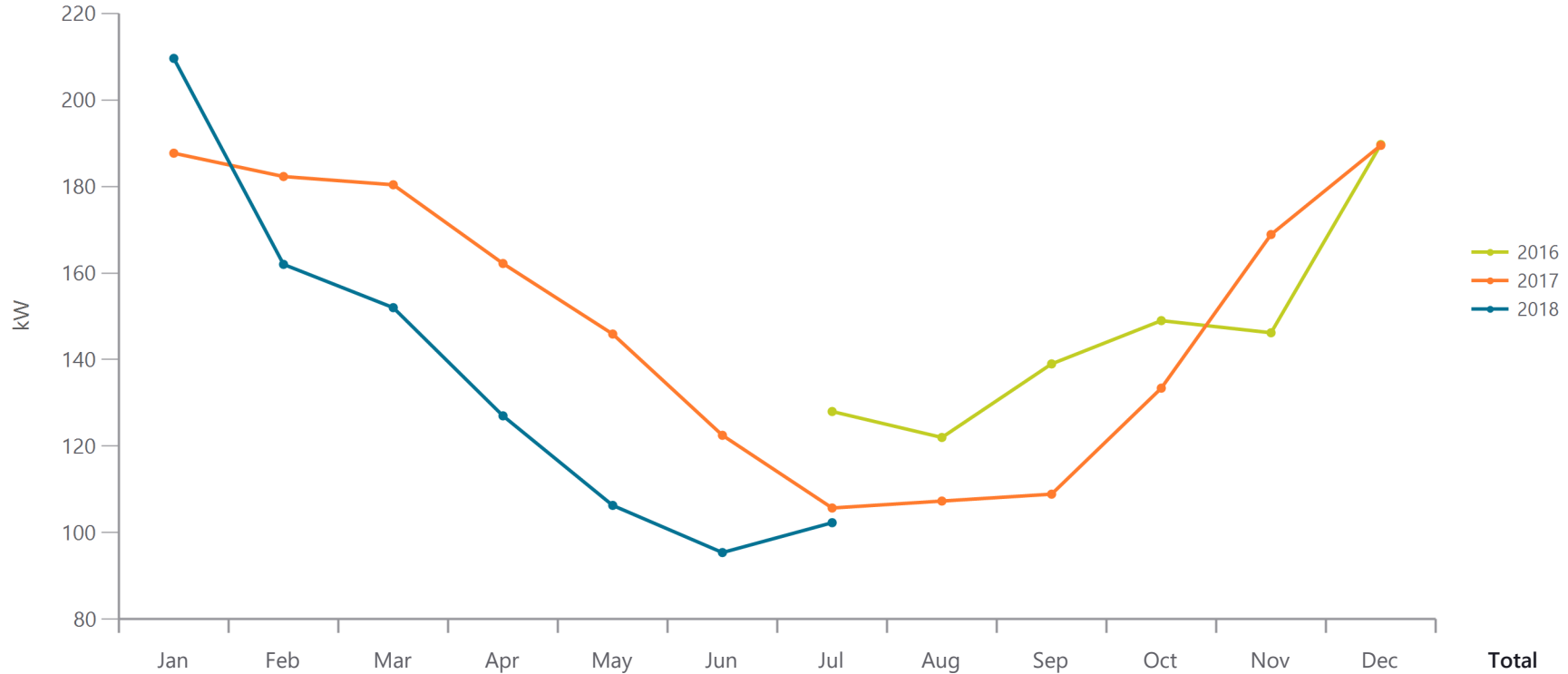
Monthly Demand by Year



	2016						128	122	139	149	146	190	874	
	2017	188	182	180	162	146	123	106	107	109	133	169	190	1,795
	2018	210	162	152	127	106	95	102					955	

Monthly Demand by Year

Executive Summary (kW)

Monthly Demand by Year

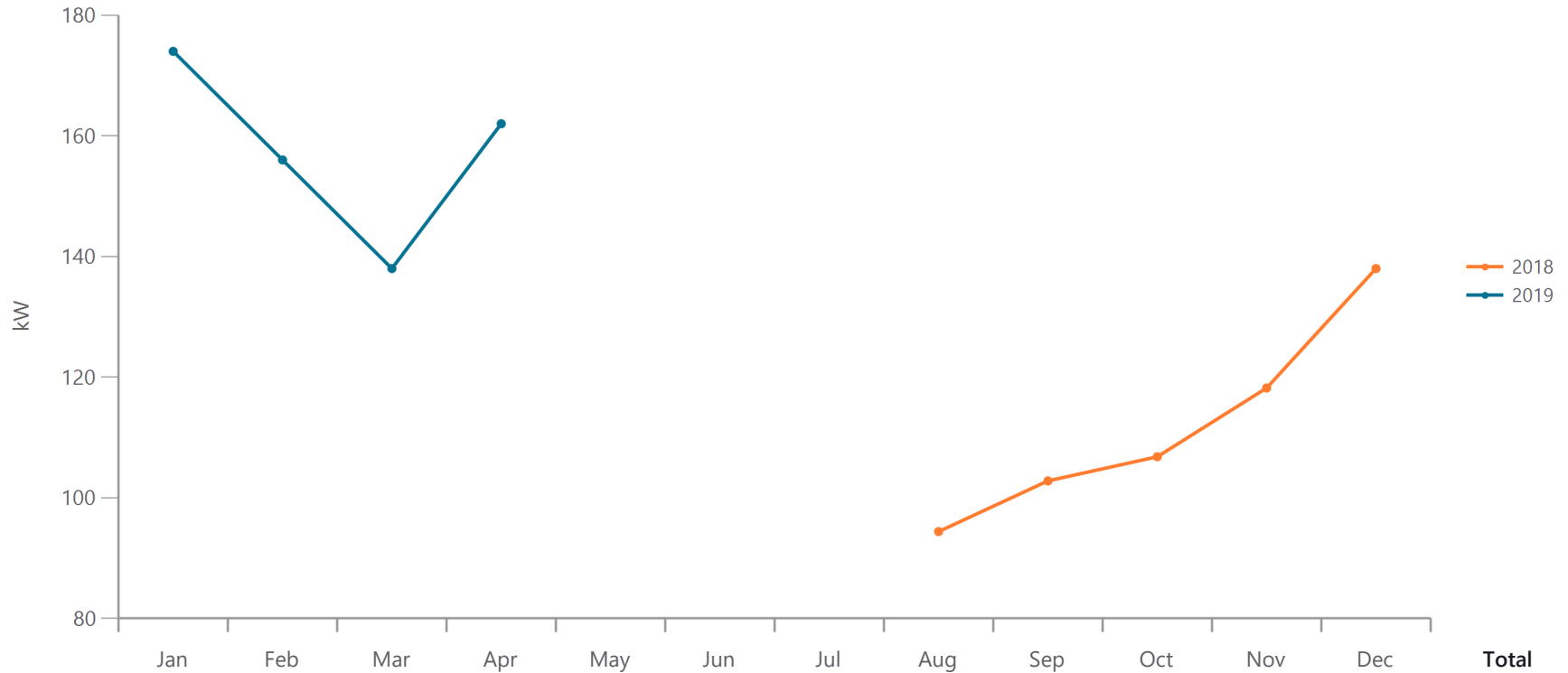

2018								94	103	107	118	138	560
2019	174	156	138	162									630



Monthly Electric Demand by Year

[SA (101) - ELEC]

Active (kW)  
Status

PEPCO  
Vendor

Germentown, MD, US 20874

Address

Monthly Electric Demand by Year

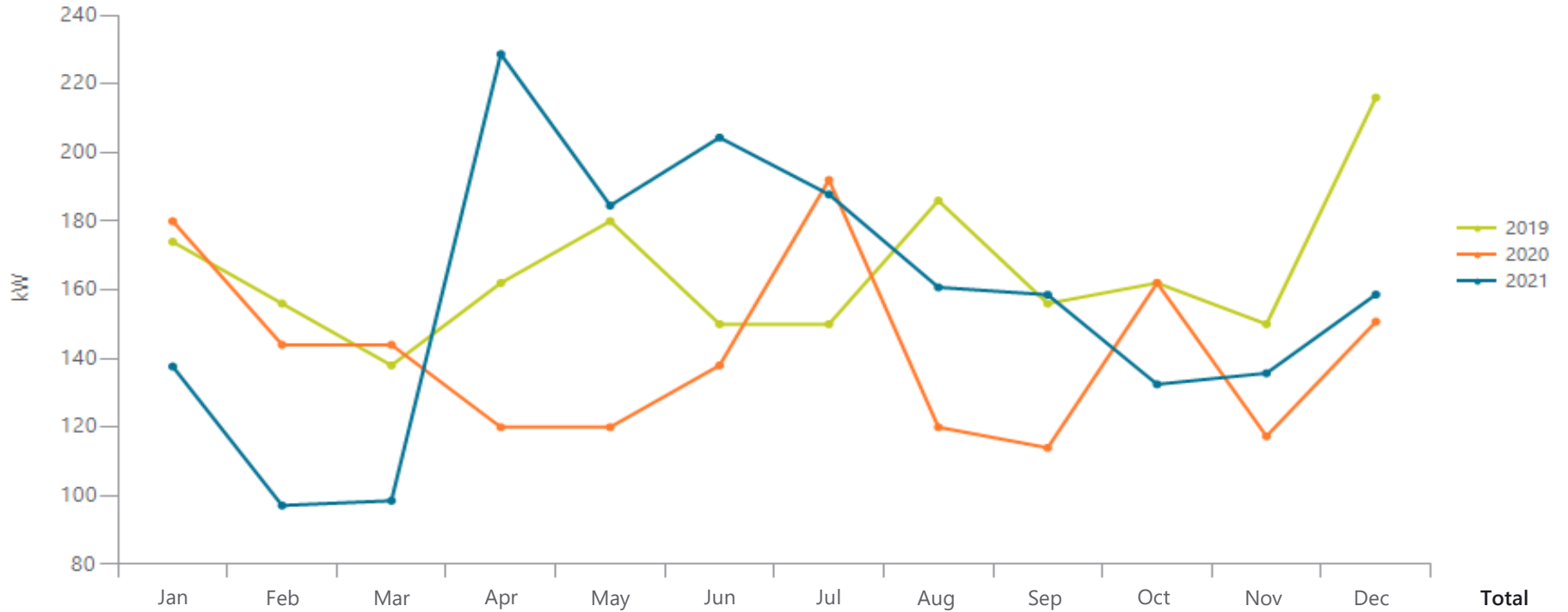

Year	Jan	Feb	Mar	Apr	May	Jun	Jul	Aug	Sep	Oct	Nov	Dec	Total
2019	174	156	138	162	180	150	150	186	156	162	150	216	1,980
2020	180	144	144	120	120	138	192	120	114	162	117	151	1,702
2021	138	97	99	229	185	204	188	161	159	132	136	159	1,885



Monthly Electric Demand by Year

[HT (104) - ELEC\_PLANT]

Active (kW)  
Status

PEPCO  
Vendor

20200 OBSERVATION DRIVE  
Germantown, MD, US 20876

Address

Monthly Electric Demand by Year

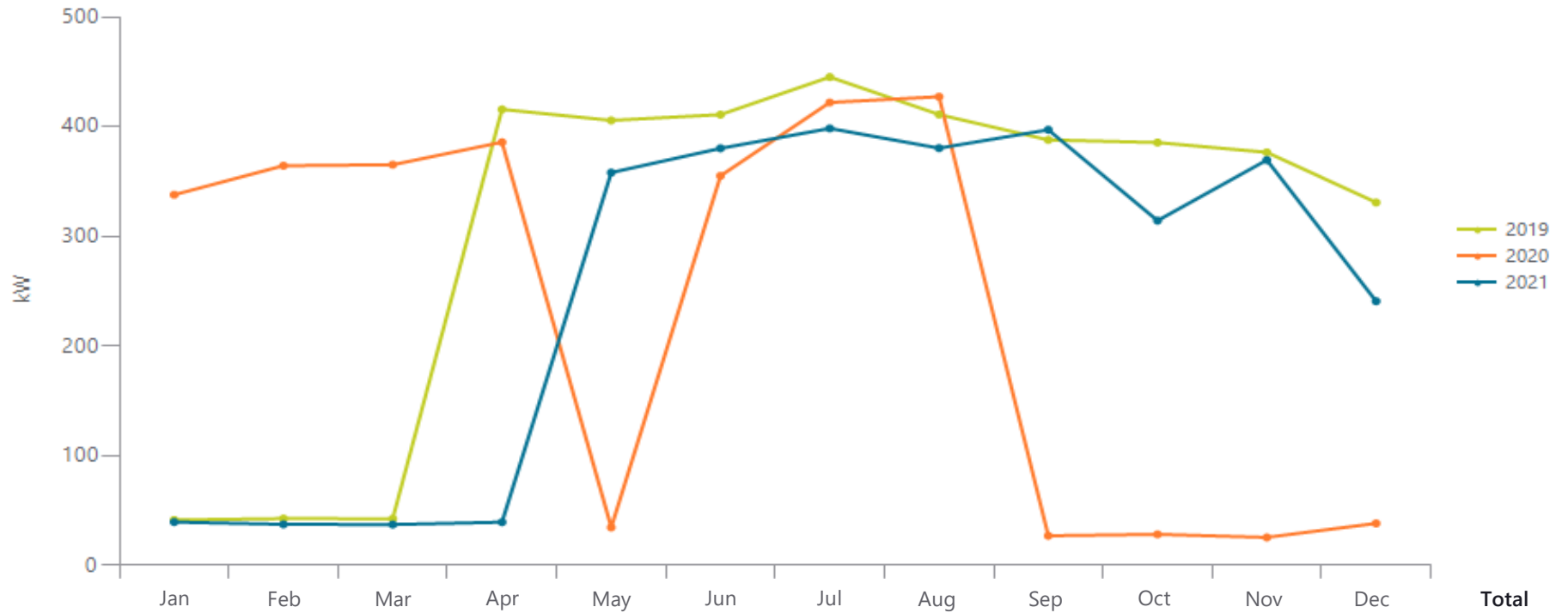

	Jan	Feb	Mar	Apr	May	Jun	Jul	Aug	Sep	Oct	Nov	Dec	Total
2019	42	43	43	416	406	411	445	411	388	386	377	331	3,697
2020	338	364	365	386	35	355	422	427	27	28	26	38	2,813
2021	40	38	37	40	358	380	398	380	397	314	370	241	2,993



Monthly Electric Demand by Year

[BE (106) - ELEC]

Active (kW)  
Status

PEPCO  
Vendor

Germantown, MD, US 20876

Address

Monthly Electric Demand by Year

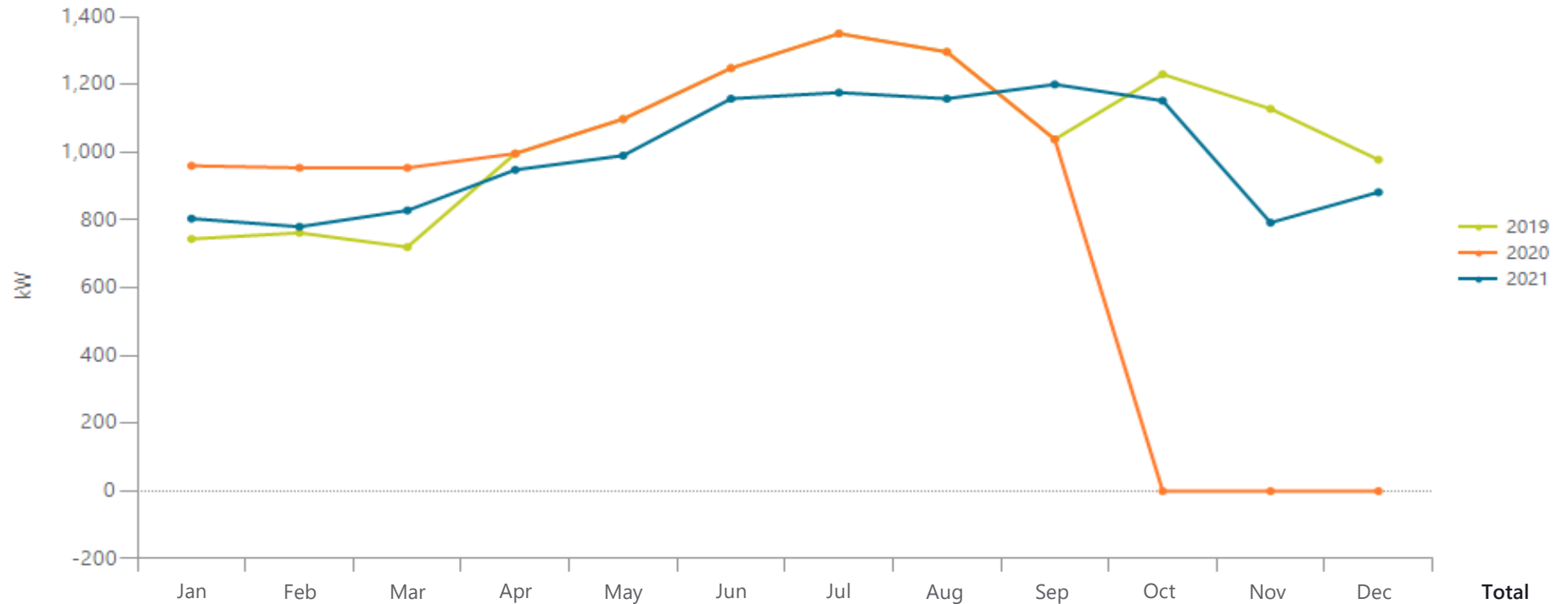

	Jan	Feb	Mar	Apr	May	Jun	Jul	Aug	Sep	Oct	Nov	Dec	Total
2019	744	762	720	996	1,098	1,248	1,350	1,296	1,038	1,230	1,128	978	12,588
2020	960	954	954	996	1,098	1,248	1,350	1,296	1,038	0	0	0	9,894
2021	804	780	828	948	990	1,158	1,176	1,158	1,200	1,152	792	882	11,868



Monthly Electric Demand by Year

[HT (104) - ELEC\_BUILDING]

Active (kW)  
Status

PEPCO  
Vendor

GERMANTOWN CAMPUS  
Germantown, MD, US 20876

Address

Monthly Electric Demand by Year

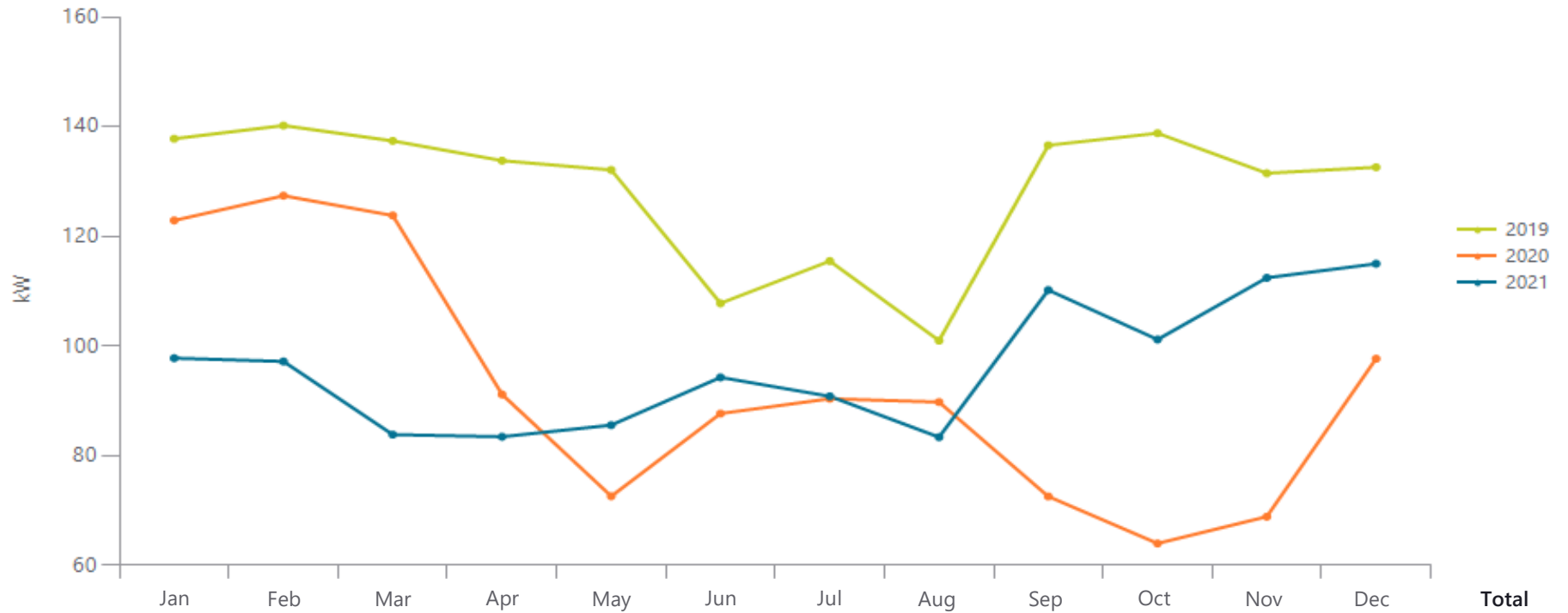

Year	Jan	Feb	Mar	Apr	May	Jun	Jul	Aug	Sep	Oct	Nov	Dec	Total
2019	138	140	137	134	132	108	116	101	137	139	132	133	1,545
2020	123	127	124	91	73	88	90	90	73	64	69	98	1,109
2021	98	97	84	83	86	94	91	83	110	101	112	115	1,155



Monthly Electric Demand by Year

[PK (105) - ELEC]

Active (kW)  
Status

PEPCO  
Vendor

Germentown, MD, US 20876

Address

Monthly Electric Demand by Year

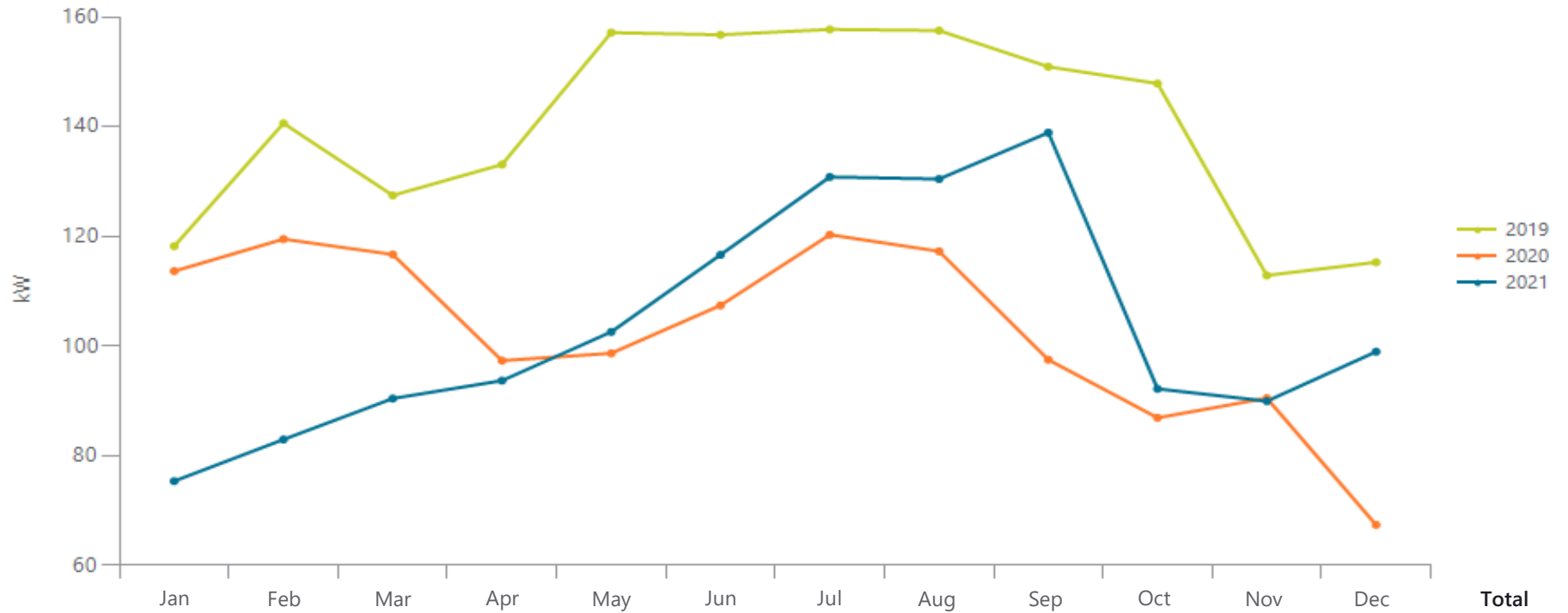

Year	Jan	Feb	Mar	Apr	May	Jun	Jul	Aug	Sep	Oct	Nov	Dec	Total
2019	118	141	127	133	157	157	158	158	151	148	113	115	1,675
2020	114	120	117	97	99	107	120	117	98	87	91	67	1,233
2021	75	83	90	94	103	117	131	130	139	92	90	99	1,243





Monthly Electric Demand by Year

[CG (107) - ELEC]

Active (kW)  
Status

PEPCO  
Vendor

20200 Observation Drive  
Germantown, MD, US 20876

Address

Monthly Electric Demand by Year

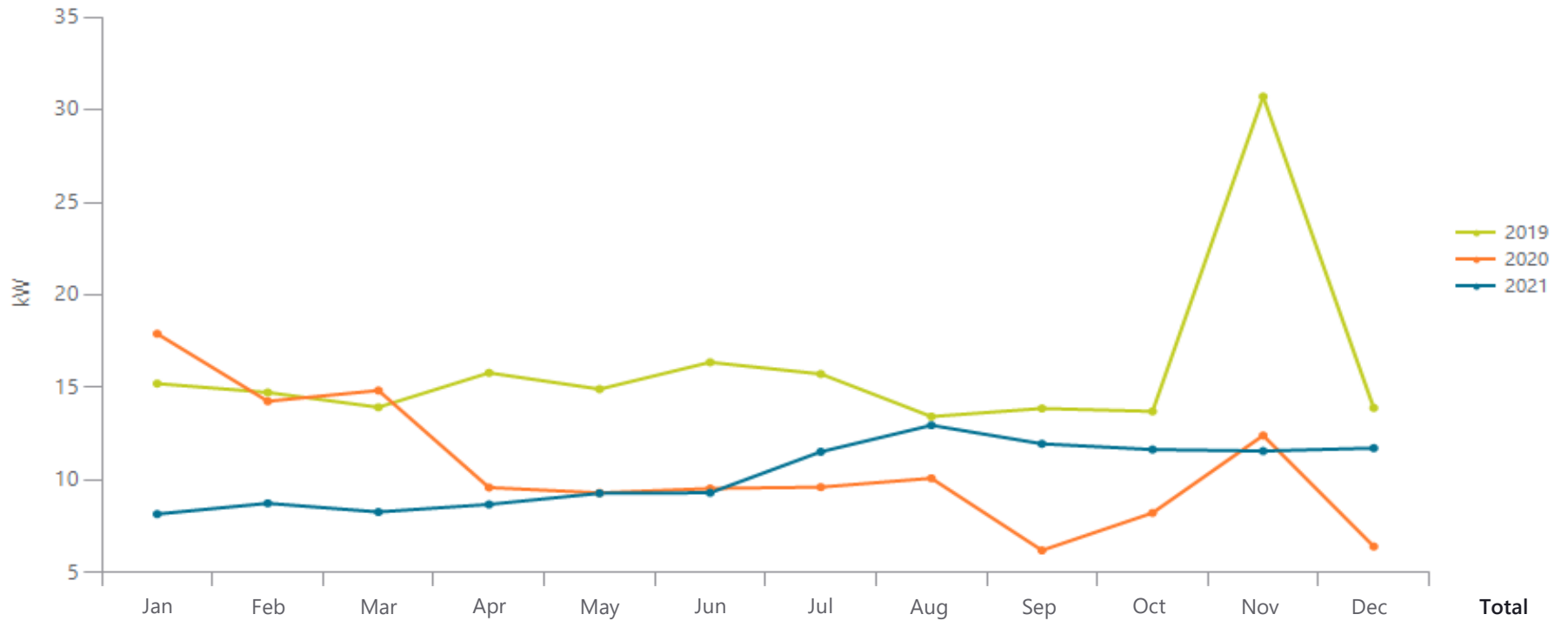

Year	Jan	Feb	Mar	Apr	May	Jun	Jul	Aug	Sep	Oct	Nov	Dec	Total
2019	15	15	14	16	15	16	16	13	14	14	31	14	192
2020	18	14	15	10	9	10	10	10	6	8	12	6	129
2021	8	9	8	9	9	9	12	13	12	12	12	12	124



Monthly Electric Demand by Year

[HS (102) - ELEC\_HS\_PG]

Active (kW)  
Status

PEPCO  
Vendor

Germentown, MD, US 20876

Address

Monthly Electric Demand by Year

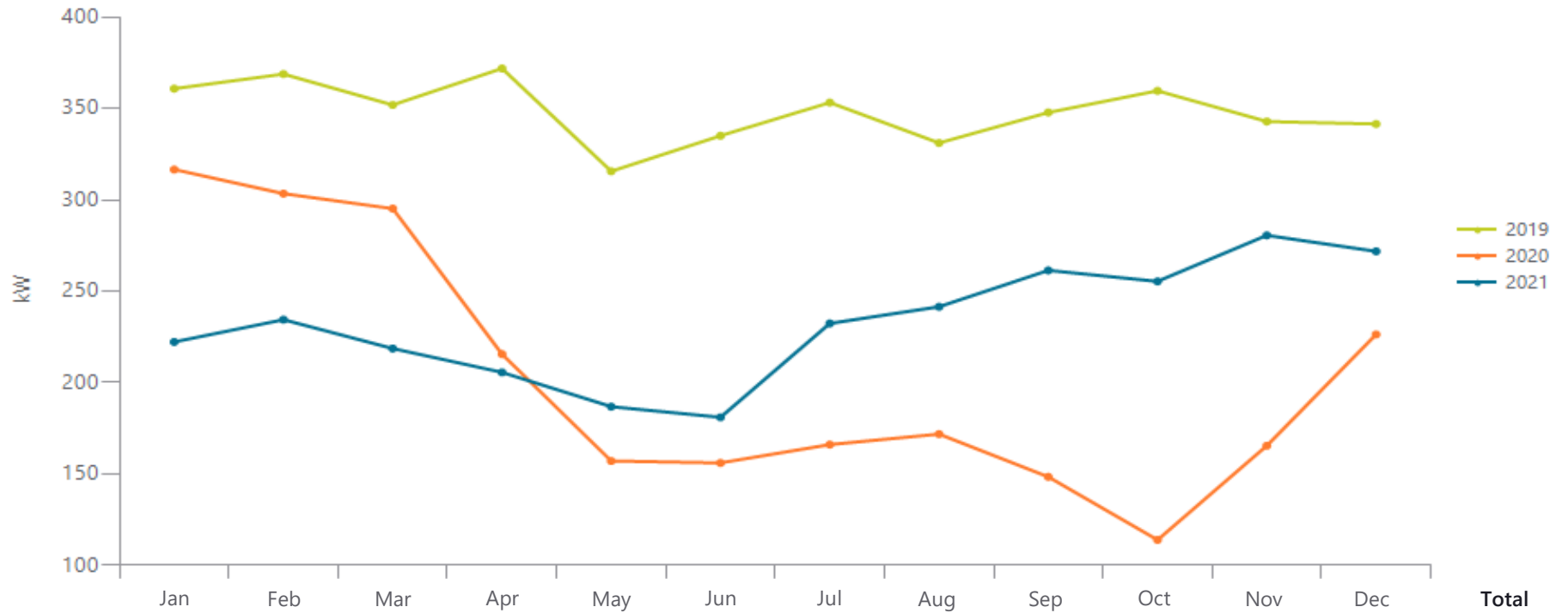

Year	Jan	Feb	Mar	Apr	May	Jun	Jul	Aug	Sep	Oct	Nov	Dec	Total
2019	361	369	352	372	316	335	353	331	348	360	343	341	4,180
2020	317	303	295	216	157	156	166	172	149	114	166	226	2,437
2021	222	234	219	206	187	181	232	242	261	255	281	272	2,792